

Part No: SA2835-UYWA02-TDKZ



## Applications/应用:

- ★ Automotive lighting  
汽车照明
- ★ Industrial Lighting  
工业照明

## Features/特征:

- ★ Package: PLCC2 package  
封装: PLCC2 封装
- ★ Device Outline: 2.8×3.5×0.7(mm)  
外形特征: 2.8×3.5×0.7 (mm)
- ★ HBM ESD: 6000V  
人体抗静电指标: 6000V
- ★ Compliance with RoHS and REACH  
符合 RoHS 和 REACH 标准
- ★ Matches AEC-Q102  
符合 AEC-Q102 标准
- ★ Emitting Color: Yellow  
发光颜色: 黄色
- ★ Viewing Angle: 120°  
发光指向角: 120°
- ★ MSL: 2a  
湿气敏感性等级: 2a
- ★ Pb-Free  
无铅

## 1、Absolute maximum ratings/极限参数:

Parameter 参数	Symbol 符号	Value 参数	Unit 单位
Power Dissipation 损耗功率	$P_d$	350	mW
Forward Current 正向工作电流	$I_{Fm}$	100	mA
Surge Current 正向峰值电流 ( $t \leq 10 \mu s$ ; $D=0.005$ ; $T_s=25 \text{ }^\circ\text{C}$ )	$I_{Fs}$	200	mA
Reverse Voltage 反向电压 ( $T_s=25 \text{ }^\circ\text{C}$ )	$V_R$	5	V
Operating Temperature 工作温度范围	$T_{opr}$	- 40 ~ +110	$^\circ\text{C}$
Storage Temperature 储存温度范围	$T_{str}$	- 40 ~ +110	$^\circ\text{C}$
Junction Temperature 结温	$T_j$	125	$^\circ\text{C}$
HBM ESD 人体抗静电指标	$V_{ESD}$	6	KV

**2、Electrical and optical characteristics/光电参数 (T<sub>s</sub> = 25°C):**

Parameter 参数	Symbol 符号	Test Condition 测试条件	Value 参数			Unit 单位
			Min.	Typ.	Max.	
Forward Current 正向工作电流	I <sub>Fm</sub>	—	10	60	100	mA
Reverse Current 反向电流	I <sub>R</sub>	VR = 5V	—	2	10	μA
Forward Voltage 正向电压	V <sub>F</sub>	IF = 60mA	2.8	—	3.5	V
Luminous Flux 光通量	Φ	IF = 60mA	18	—	24	Lm
Dominant Wavelength 主波长	λ <sub>dom</sub>	IF = 60mA	585	—	594	nm
Viewing Angle 发光指向角	2θ <sub>1/2</sub>	IF = 60mA	—	120	—	Deg.
Thermal Resistance (Junction to Solder) 热阻 (PN 结/焊点)	Real 实测 R <sub>th JS real</sub>	IF = 60mA	—	—	50	K/W

**Notes/备注:** Error/误差: VF: ±0.10V, IV: ±8%, Other/其它: ±5%

### 3、Product Ranks/产品分档范围:

#### Brightness Grading / 亮度分档 (LM)

(Ta=25°C; IF=60mA)

Rank	Luminous Flux 光通量 (min)	Luminous Flux 光通量 (max)
L18	18	20
L20	20	22
L22	22	24

**Notes/备注:** Brightness error/亮度误差:  $\pm 8\%$

#### Voltage grading / 电压分档 (V)

(Ta=25°C; IF=60mA)

Rank	Voltage 电压 (min)	Voltage 电压 (max)
N	2.8	2.9
P	2.9	3.0
Q	3.0	3.1
R	3.1	3.2
S	3.2	3.3
T	3.3	3.4
U	3.4	3.5

**Notes/备注:** Voltage error/电压误差:  $\pm 0.10V$

#### Wavelength Grading / 波长分档 (nm)

(Ta=25°C; IF=60mA)

Rank	Dominant Wavelength 主波长 (min)	Dominant Wavelength 主波长 (max)
Y2	585	588
Y3	588	591
Y4	591	594

**Notes/备注:** Wavelength error/波长误差:  $\pm 1nm$

#### 4、Characteristics Graph/特性曲线:

Fig.1 Relative spectral curve

相对光谱曲线

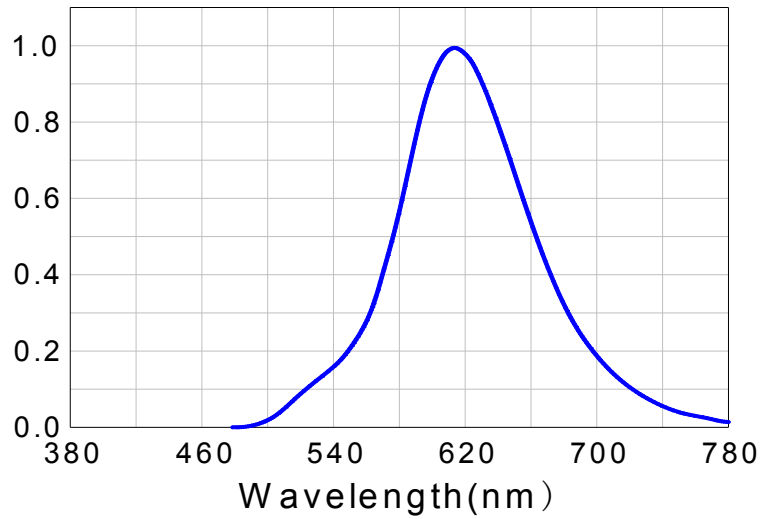

Fig.2 Radiation Characteristic

辐射特性

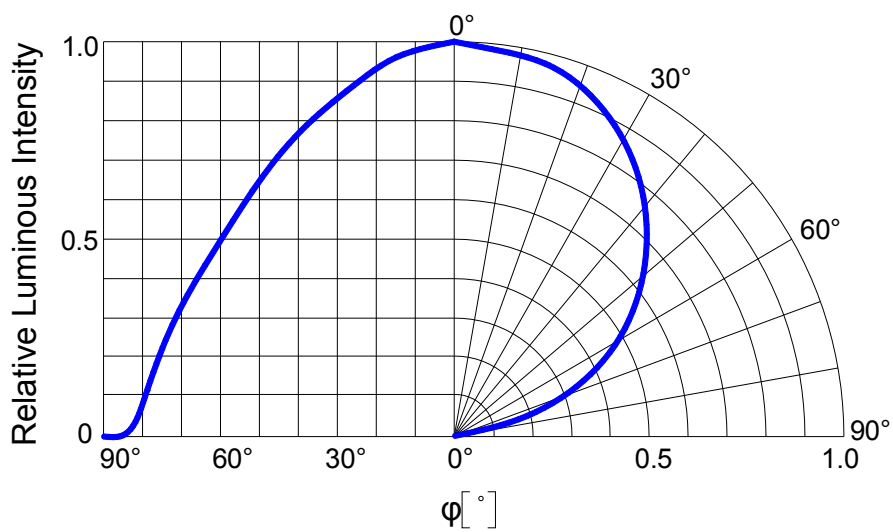

Fig.3 Forward Current vs. Forward Voltage

正向电流 Vs. 正向电压

$$I_F=f(V_F); T_S=25^{\circ}\text{C}$$

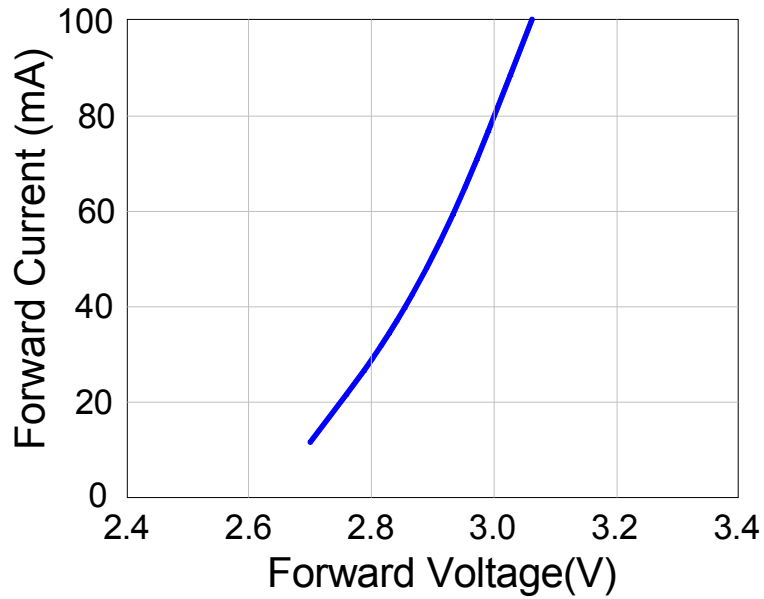

Fig.4 Relative Luminous Flux vs. Forward Current

相对光通量 Vs. 正向电流

$$\Phi/\Phi(60\text{mA})=f(I_F); T_S=25^{\circ}\text{C}$$

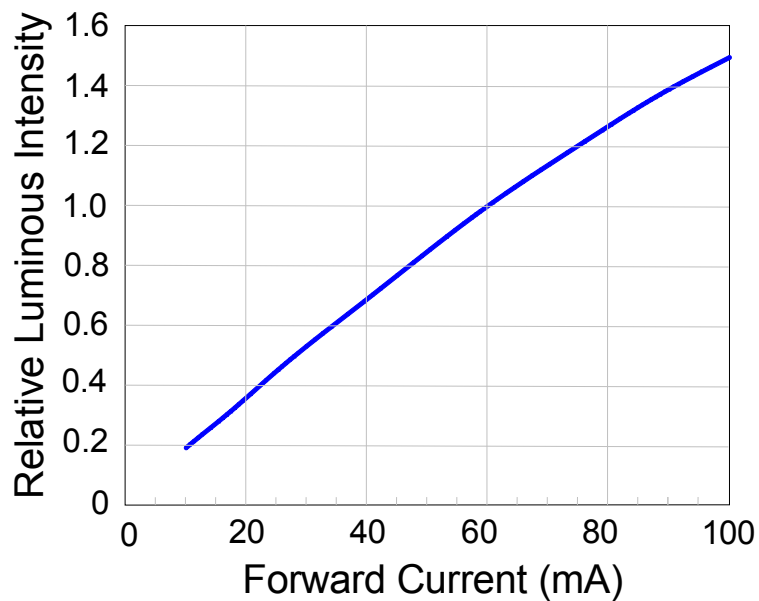

Fig.5 Dominant Wavelength vs. Forward Current

主波长 Vs. 正向电流

$$\lambda_d = f(I_F); T_S = 25^\circ\text{C}$$

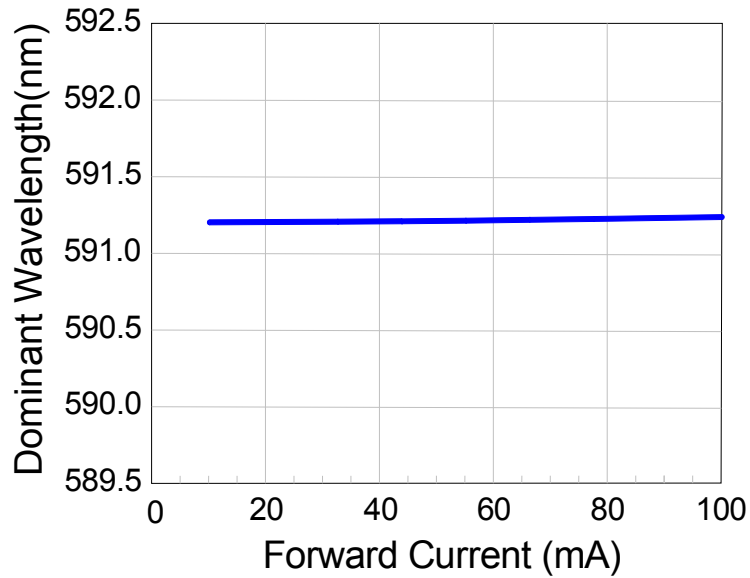
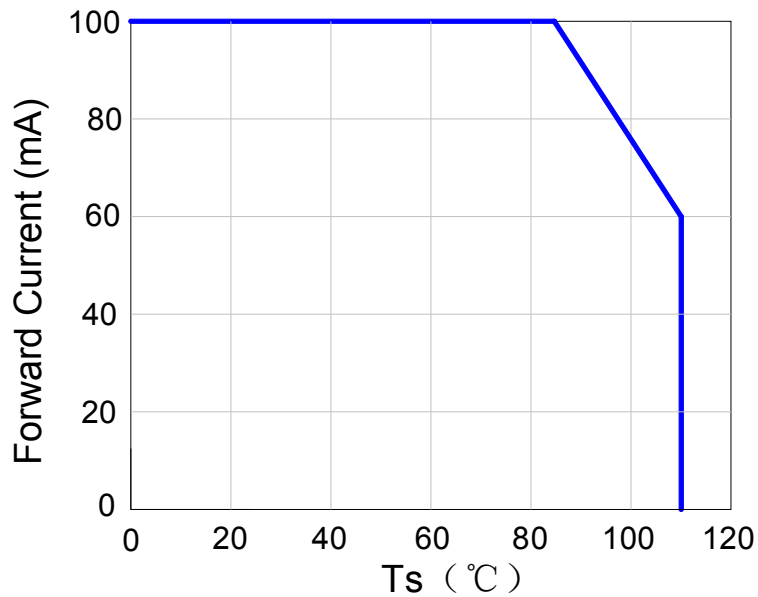
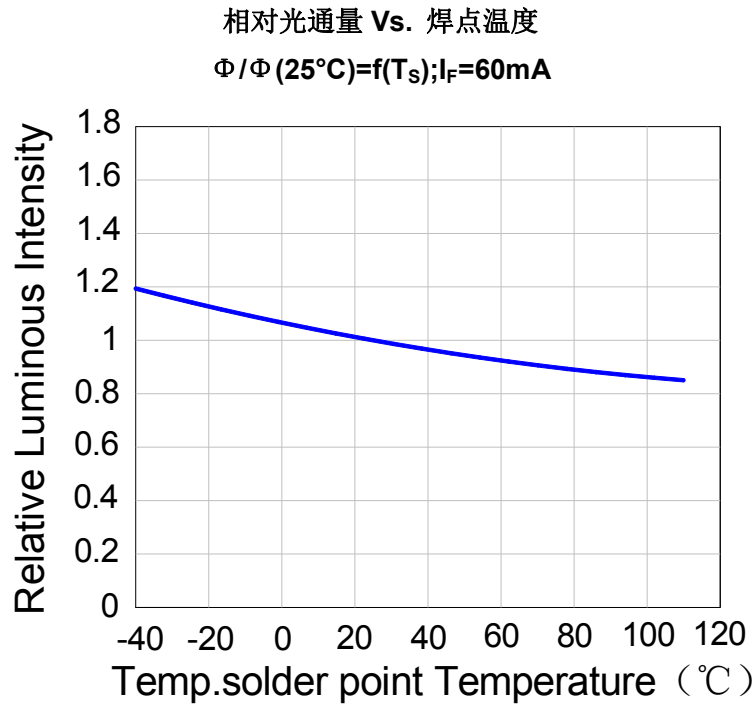

Fig.6 Max. Permissible Forward Current

容许最大正向电流



**Fig.7 Relative Luminous Flux vs. Temp.solder point Temperature**



**Fig.8 Relative Forward Voltage vs. Temp.solder point Temperature**

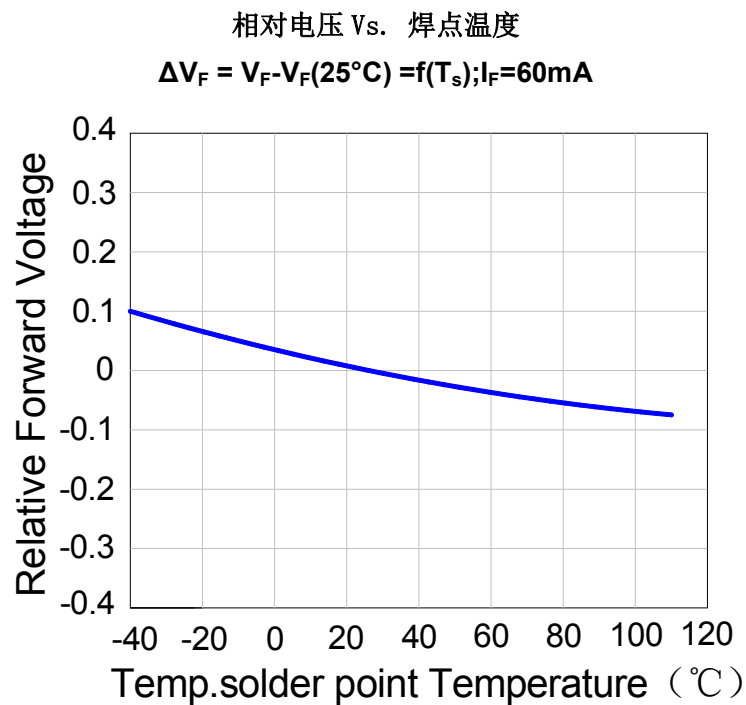
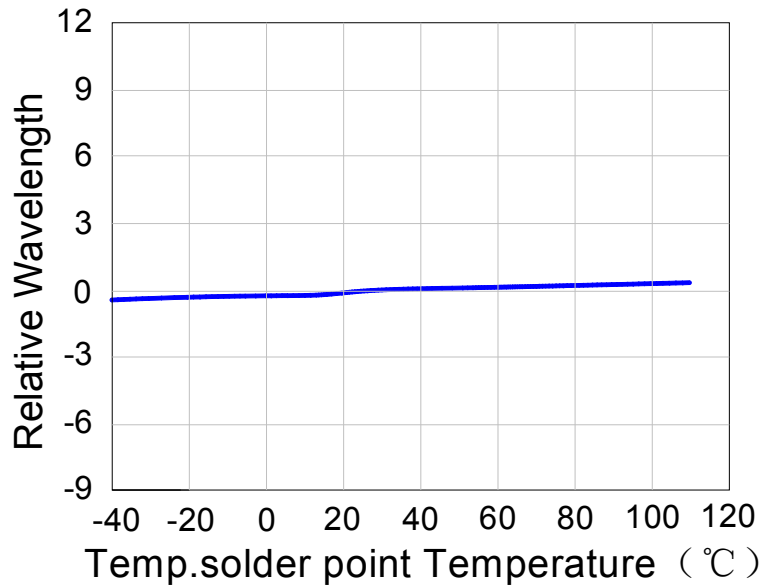



Fig.9 Relative Wavelength vs. Temp.solder point Temperature

相对波长 Vs. 焊点温度

$$\Delta\lambda_d = \lambda_d - \lambda_d(25^\circ\text{C}) = f(T_s); I_F = 60\text{mA}$$



### 5、Outline Dimensions/产品外形尺寸:

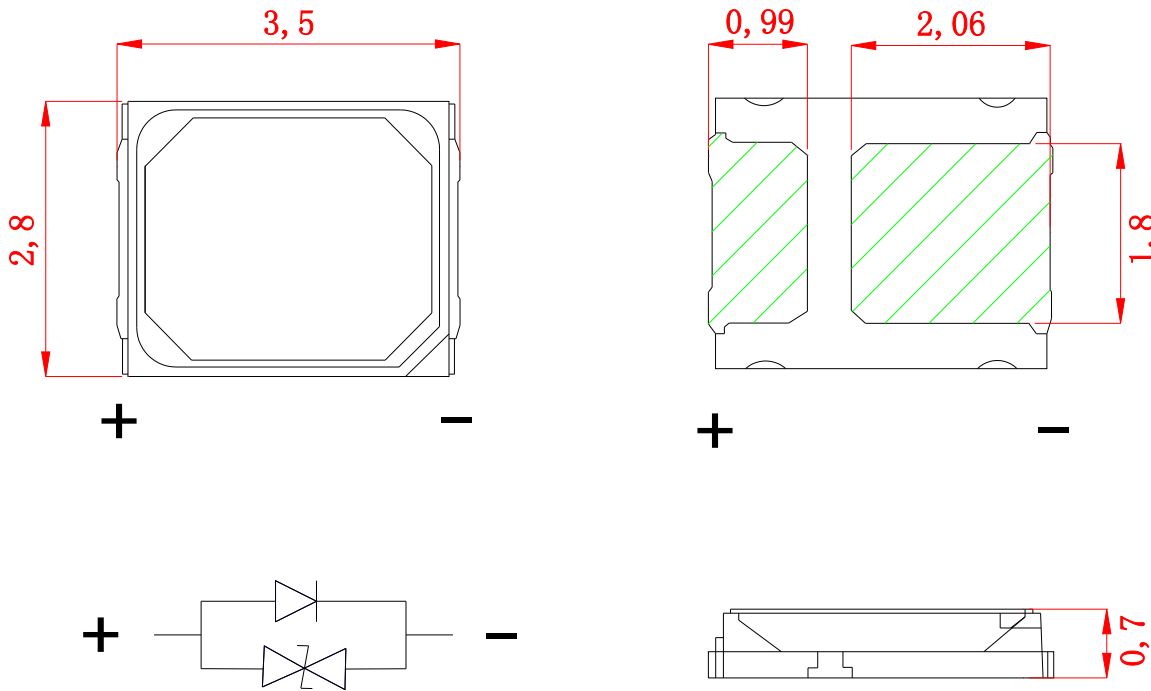

Notes/备注：Tolerance is  $\pm 0.1\text{mm}$  (公差 $\pm 0.1\text{mm}$ )

### 6、Reference Pad size/参考焊盘尺寸:

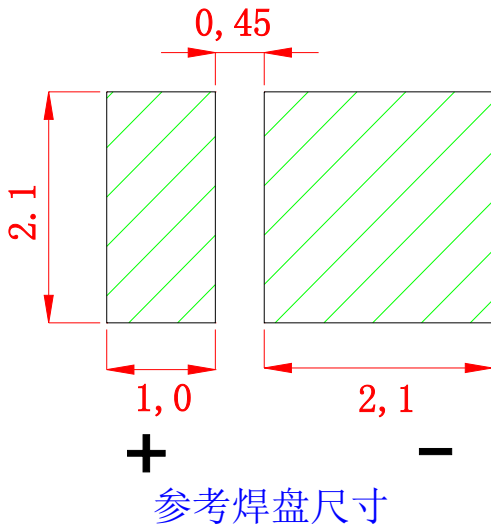

Notes/备注:

- 1、Tolerance is  $\pm 0.1\text{mm}$  (公差 $\pm 0.1\text{mm}$ )
- 2、For superior solder joint connectivity results we recommend soldering under standard nitrogen atmosphere. Package not suitable for ultra sonic cleaning./ 为了获得更佳的焊点连接效果，我们建议在标准氮气环境下进行焊接。封装不适合超声波清洁。

## 7、Reflow curve /回流焊曲线

Product complies to MSL Level 2a. to JEDEC J-STD-020E

产品符合 MSL 等级 2a 根据 JEDEC J-STD-020E

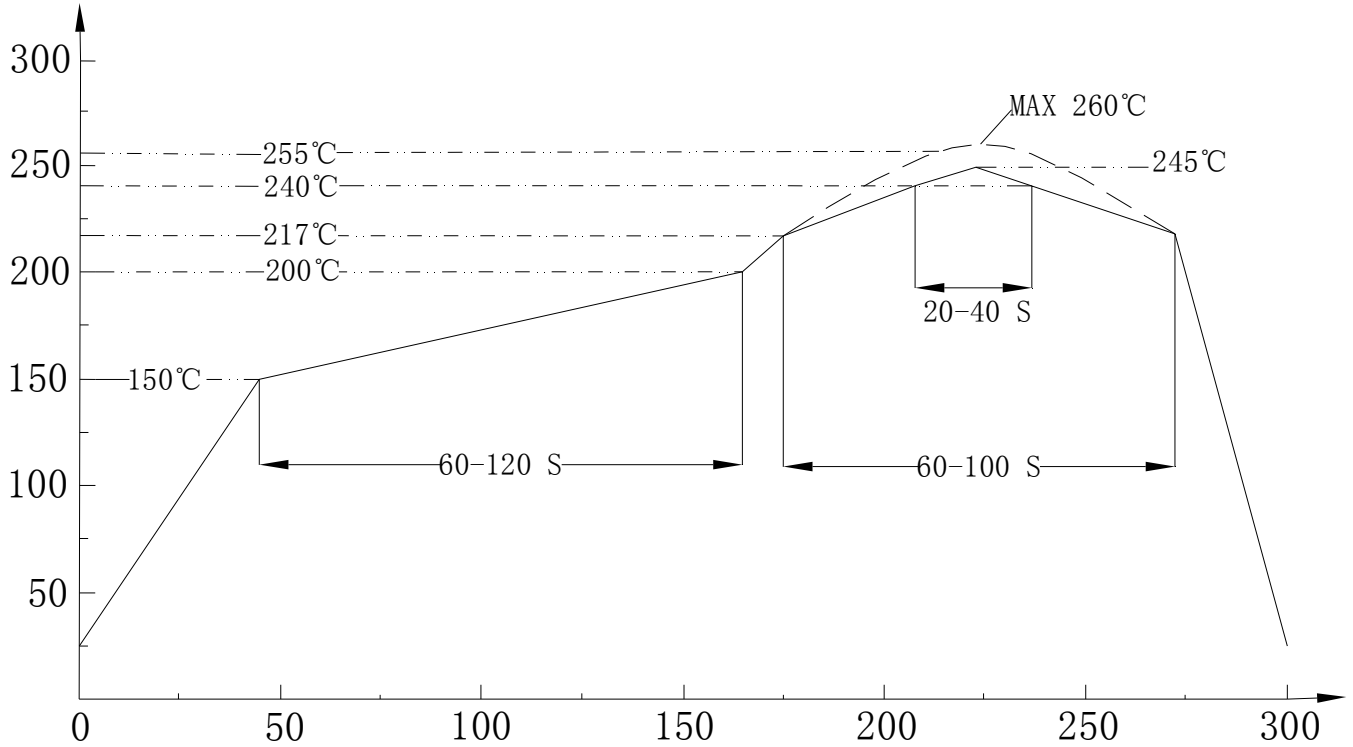



Curvilinear feature 曲线特征	Lead-free combination/无铅组合	Unit/单位
	Recommended criteria/建议标准	
Average preheating heating rate 25 °C to 150 °C 预热平均升温速率 25°C至 150°C	2	°C/sec
Warm-up time 预热时间	60-120	secs
Reflux temperature 回流温度	217	°C
Reflux time 回流时间	60-100	secs
Peak temperature(max) 峰值温度 (最大)	260	°C
The time when the actual peak temperature is within 5 °C 实际峰值温度在 5°C 以内的时间	20-40	secs
Cooling rate 降温速度	4	°C/sec

Notes/备注: Hand Soldering (Not Recommended) /手工焊接 (不推荐)

## 8、 Specification of Packing /包装规格

### 8.1 Label Form Specification/标签格式规范

 	
P/N: _____	
Vf : _____	XY: _____
Tc/Wd: _____	If: _____
Φ /Iv: _____	Qty: _____
Date: _____	QC: _____
Lot No: _____	

P/N: Product code 产品编号

Vf: Voltage电压

XY: Color Group色系

Tc/Wd: Color Temperature色温/ Dominant Wavelength 主波长

IF: Test Current测试电流

Φ/Iv: Luminous flux光通量/ Luminous Intensity 发光强度;

Qty: Packing Quantity包装数量

Date: Year年- Month月- Date日

Lot No: Production batch Number生产批号

### 8.2 Taping and Orientation/编带和方向(Reel packing/卷盘包装: 4000PCS)

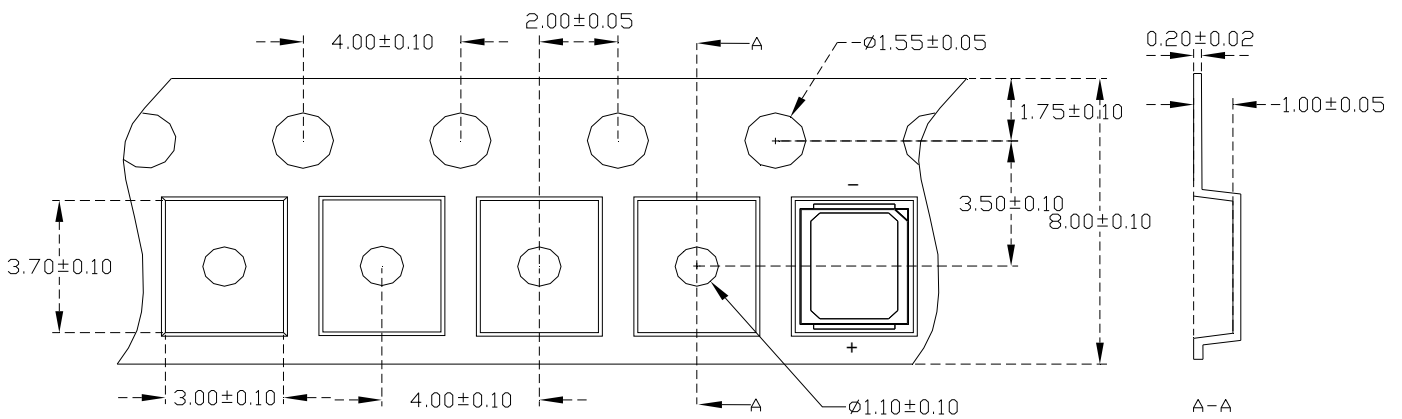

8.3 Specification of Packing/包装规格

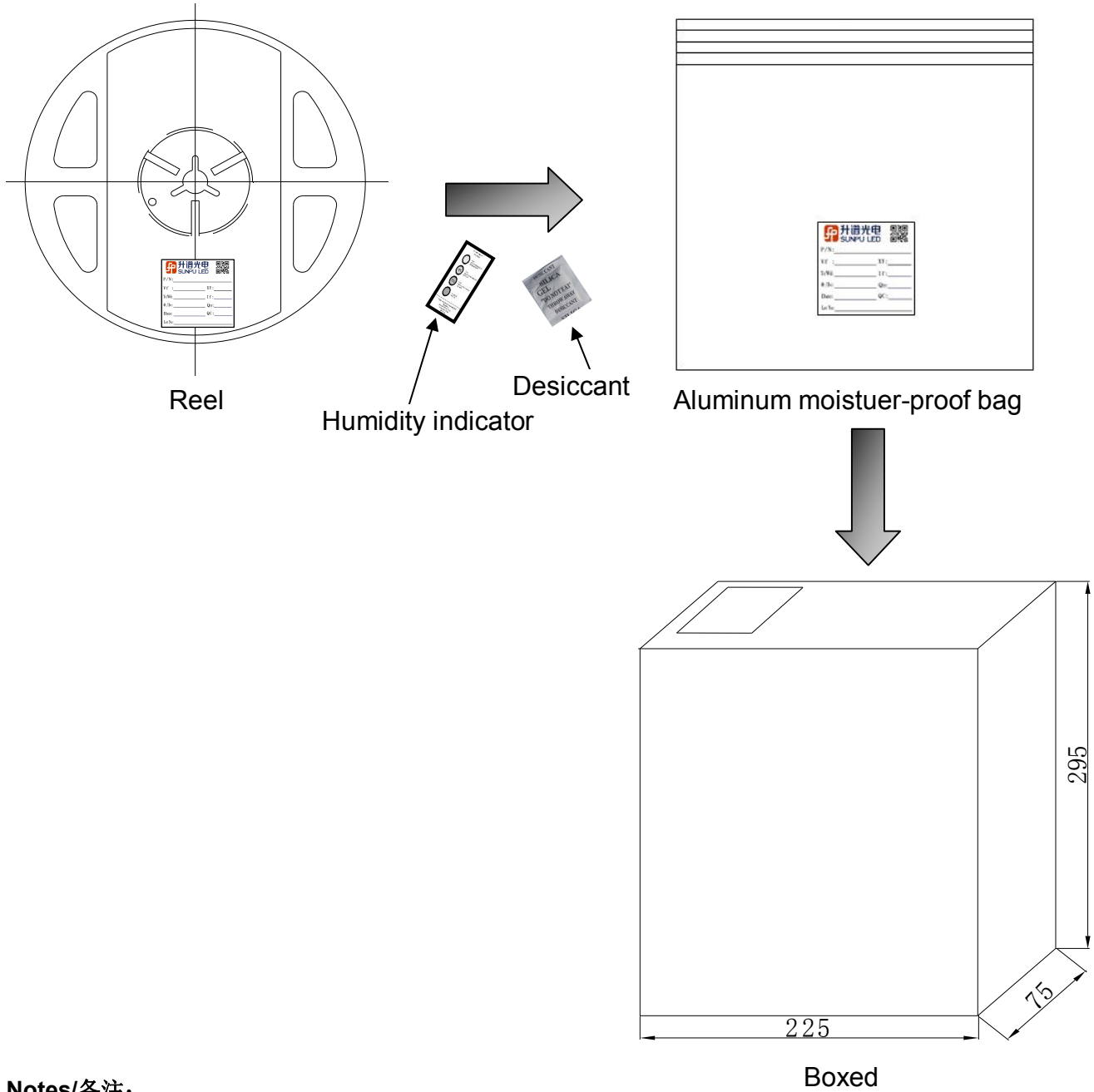

**Notes/备注:**

- ◆ Reel packing/卷盘包装: 4000PCS
- ◆ Boxed/盒装: 5 Bags (20000PCS)
- ◆ humidity sensitive products packed in aluminum foil bags, containing humidity cards and desiccant. 湿敏产品包装在铝箔袋中, 内含湿度卡和干燥剂。

## 9、Notes/注意

9.1 LED operating environment and sulfur element composition cannot be over 100PPM in the LED mating usage material.

LED 工作环境及与 LED 适配的材料中硫元素及化合物成份不可超过 100PPM。

9.2 Not suitable to operate in acidic environment, PH<7

LED 不可用在 PH<7 的酸性环境。

9.3 Please note that the Light Board in the test, not live plug-in operation, to avoid the instant high current LED breakdown

请注意灯板在测试时，不可带电插拔作业，避免 LED 受到瞬间大电流击穿

9.4 To ensure the quality of our LEDs, So please do not put pressure on the LEDs. Do not fold, bend or squeeze LED devices

为确保 LED 的可靠性，在操作过程中不可施加压力在 LED 器件胶体表面。不可折叠、弯曲、挤压 LED 器件。

9.5 in order to ensure the reliability of LED, sealed packaging is recommended for semi-finished products or module components that have been pasted during circulation, transportation and storage.

为确保 LED 的可靠性,已贴片好的半成品或模组组件，在流转、运输、储存过程中建议密封包装。

9.6 After opening the bag: The LEDs should be soldered within 24 hours after opening the package. If unused LEDs remain, they should be stored in moisture proof bags with moisture absorbent material. It recommended that the user use the LEDs as soon as possible. If the LEDs have exceeded the storage time or the moisture absorbent material has faded away. Baking process should be performed by using more than 24hours baking at  $60 \pm 5^{\circ}\text{C}$  before using LEDs.

拆开包装袋之后：产品应该在拆封后的 24 小时内焊接完毕；如果没用完，产品应该储存在带有干燥剂的防潮包装袋中；建议客户尽快的使用完产品；如果产品超出了使用期限或者干燥剂失效，那么产品在使用前必须在  $60 \pm 5^{\circ}\text{C}$  中烘烤至少 24 小时。

9.7 To ensure the reliability of LED, please complete one time welding, not too many reflow soldering, otherwise on the bead will have a destructive impact. Repair should not be done after the LEDs have been soldered. When repairing is unavoidable, a double-head soldering iron should be used (as below figure).

为确保 LED 的可靠性，请一次焊接完成，不可过多次回流焊，否则对灯珠会有破坏性影响。LED 焊接后不应进行维修。如不得不修理，应使用双头烙铁(如图所示)。

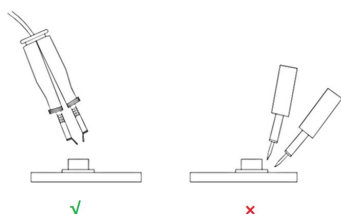

## 附1、Revision History /修订历史

Rev 版本号	Revision time 修订时间	Revisions 修订内容
A0	2023/02/01	初始版本
A1	2023/08/04	LOGO 更新 去除“附2”