



**Sunpu-opto**  
Better LED, Better Life

---

# Product Acknowledgment

**Included:** Performance characteristics, Mechanical dimensions, Characteristic curves, Reliability packing, and Instructions for use.

**Model:** TH17B-27H60H-0312KA-N

Manufacturers    Client Confirm (Quality)    Client Confirm (R & D)

Prepared

Audit

Approve

## Contact

---

Ningbo SunpuOptoSemiconductor Co., Ltd  
No.150, Xin Hui Road, Hi-Tech Park, Ningbo

0574-87740939

[www.sunpuled.com](http://www.sunpuled.com)

---

## Product Nomenclature

TH17B	27	H	60	H	03	12	K	A	-N
1	2	3	4	5	6	7	8	9	
1: Substrate type									
2: Color temperatur									
3: Ra									
4: Color temperatur									
5: Ra									
6 : The number of parallel									
7 : The number of series									
8: Internal encoding									
9: A:ANSI B:IEC									

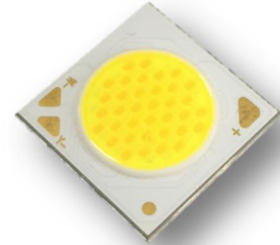

The series of products ,which use mirror aluminum for substrate.The products have high brightness, long life, a variety of power, easy installation, general size, which are especially suitable for indoor and outdoor lighting products, etc.

## Features

- High brightness、 high reliability、 long life
- Light angle: 120°
- Typical color temperature: 2700K/6000K
- Ra : 80+

## Content

Outline dimensions & Circuit structure	3
Limit parameter	3
Photoelectric parameters	4
Chromaticity Coordinates Ranks	4
Typical curve	5
Optical Characteristics	5
Reliability test and results	8
Label instructions	9
Using and attention	10

## Outline dimensions & Circuit structure

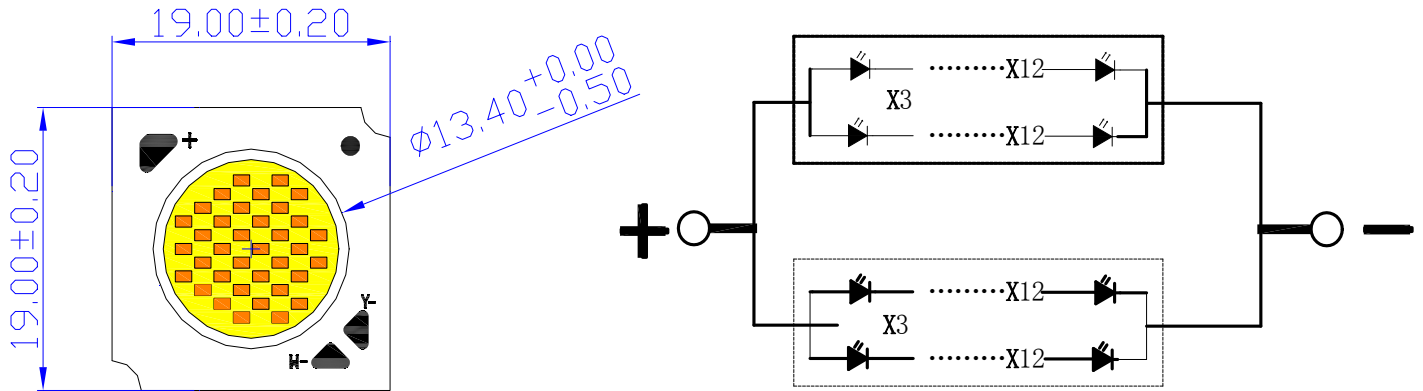

### NOTES:

- All dimensions are millimeter.
- Tolerance is  $\pm 0.3\text{mm}$  unless otherwise noted.
- It is strongly recommended that the temperature of TS (Welding plate) is not higher than  $90^{\circ}\text{C}$ .

## Limit parameter (Ta = 25°C)

Parameter	Symbol	Test Condition	Value		Unit
			Min.	Max	
DC Forward Current	IF	----	----	1500	mA
Peak Pulse Current	Ipeak	Duty=1/10 1kHz	----	1875	mA
Power Dissipation	Pd	----	----	45	W
LED Junction Temperature	TJ	----	----	125	°C
Operating Temperature	Topr	----	-40	+85	°C
Storage Temperature	Tstr	----	-40	+100	°C
ESD Sensitivity	----	HBM	2000	----	V
Soldering Temperature	----	----	350°C for 5 Seconds max		

## Photoelectric parameters (Ta = 25°C)

CCT	Item	Symbol	Test Condition	Min	Typ	Max	Unit
2700K	Forward Voltage	VF	IF=900mA	--	36	--	V
	Luminous Flux	Φ		3400	--	--	lm
	Color Temperature	CCT		2650	2725	2800	K
	General Color Rendering Index	Ra		80	--	--	
	Thermal Resistance	RJ		--	0.8	--	°C/W
6000K	Forward Voltage	VF	IF=900mA	--	36	--	V
	Luminous Flux	Φ		3900	--	--	lm
	Color Temperature	CCT		5720	6000	6350	K
	General Color Rendering Index	Ra		80	--	--	
	Thermal Resistance	RJ		--	0.8	--	°C/W

## Chromaticity Coordinates Ranks(IF=900mA Ta=25°C)

Standards	Colour temperature	Center of Coordinates	Long axis	Minor axis	Gradient	Colour temperature	Explain
	TC	X	Y	a	b	TC	SDCM
ANSI	6500K	0.3123	0.328 <sub>2</sub>	0.0089 <sub>2</sub>	0.0038	6500K	4-step MacAdam
	5000K	0.3447	0.355 <sub>3</sub>	0.0082 <sub>2</sub>	0.0035 <sub>4</sub>	5000K	3-step MacAdam
	4000K	0.3818	0.379 <sub>7</sub>	0.0093 <sub>9</sub>	0.0040 <sub>2</sub>	4000K	
	3500K	0.4073	0.391 <sub>7</sub>	0.0095 <sub>1</sub>	0.00417	3500K	
	3000K	0.4338	0.403	0.0071 <sub>4</sub>	0.0040 <sub>8</sub>	3000K	
	2700K	0.4578	0.410 <sub>1</sub>	0.0077 <sub>4</sub>	0.00411	2700K	
IEC	6500K	0.3130	0.337	0.0089	0.0038	6500K	4-step

			0	2			MacAdam
	5000K	0.3460	0.3590	0.00822	0.00354	5000K	3-step MacAdam
	4000K	0.3800	0.3800	0.00939	0.00402	4000K	
	3500K	0.4090	0.3940	0.00951	0.00417	3500K	
	3000K	0.4400	0.4030	0.00714	0.00408	3000K	
	2700K	0.4630	0.4200	0.00774	0.00411	2700K	
Sunup-6000K	6000K	0.3217	0.3303	0.00892	0.0038	6000K	4-step MacAdam
Code				Colour temperature			
W27				2700K			
W30				3000K			
W35				3500K			
W40				4000K			
W50				5000K			
W60				6000K			
W65				6500K			

**NOTES:**

- Our company deliver according to the 3 order macadam ellipses among 2700K-5000K and deliver the 4 order macadam ellipses among 6000K-6500K for above 3 stands.
- Tolerance of measurements of the Forward Voltage is  $\pm 2\%V$
- Tolerance of measurements of the Luminous Flux is  $\pm 15\%$
- Tolerance of measurements of the Color Rendering Ra is  $\pm 2$
- Chromaticity Coordinates (x,y) is measured with an accuracy of  $\pm 0.01$
- The center of Coordinates (x,y) is based on C78.377:2008 ANSI reference
- Ellipse refer to IEC 60081:1997
- Ranking at TC=25°C

## Typical curve

Fig.1 Forward Current (mA) Vs Forward Voltage (V)

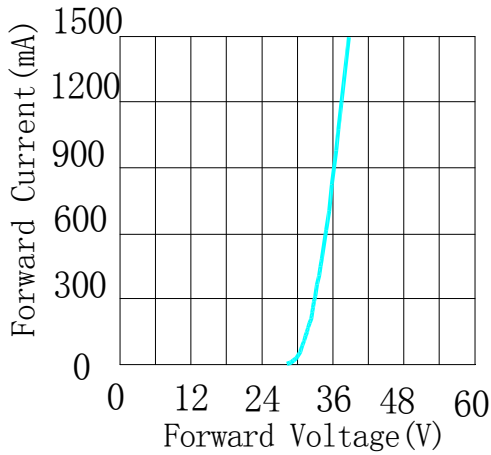

Fig.2 Relative Intensity Vs Forward Current (mA)

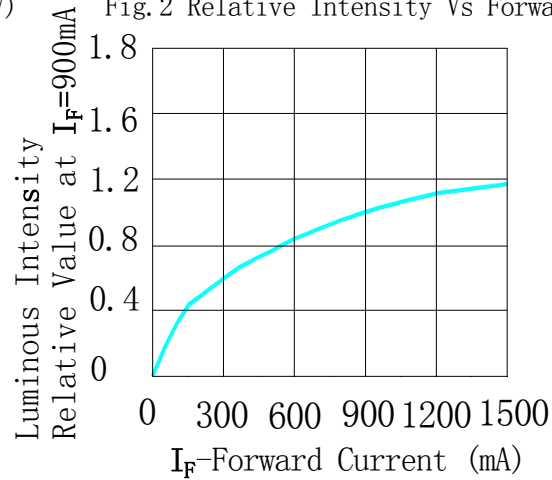

Fig.3 Forward Current Vs Ambient Temperature

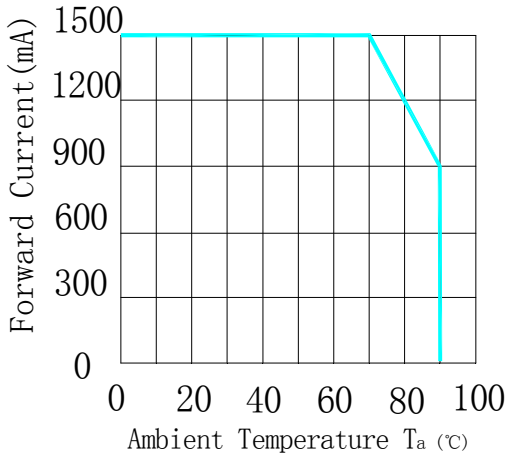
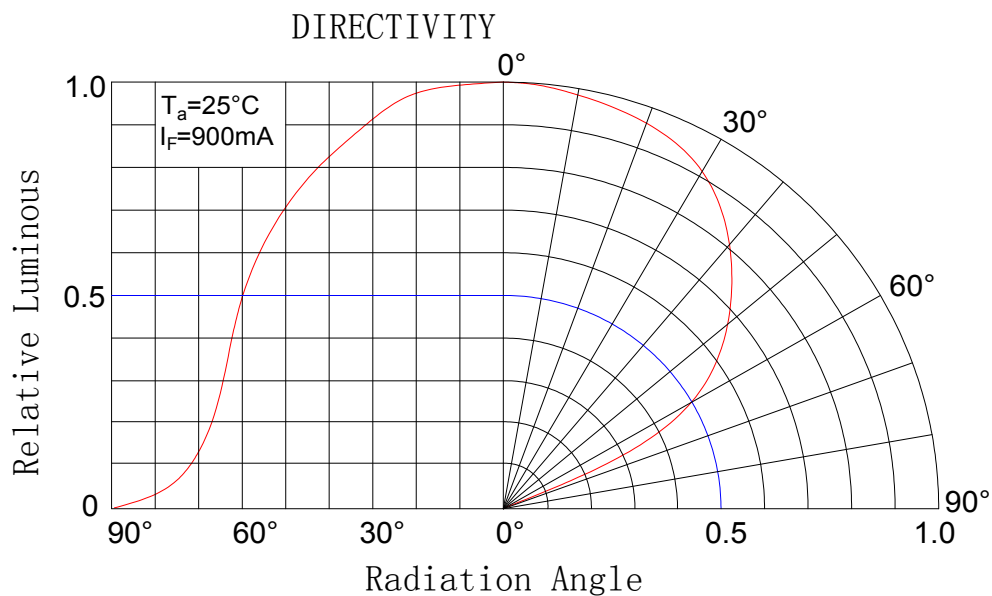
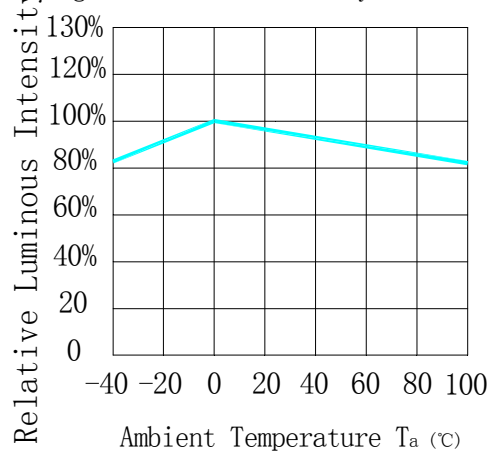
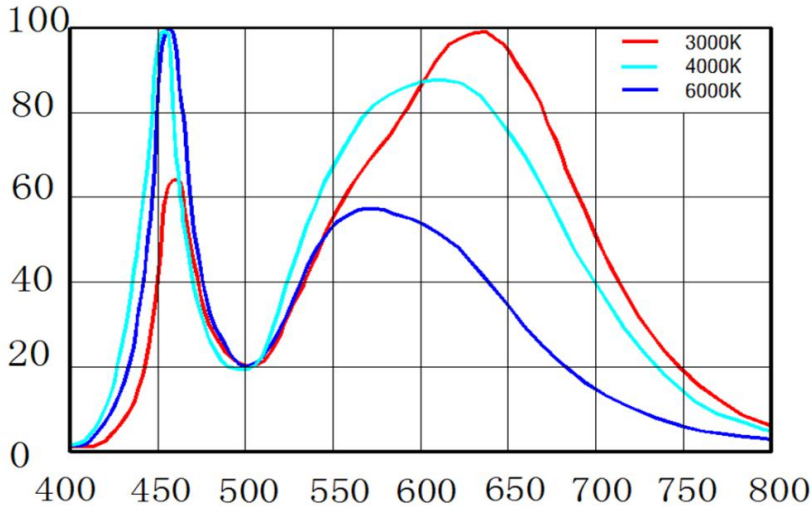

Fig.4 Relative Intensity Vs Ambient Temperature



## Optical Characteristics

Spectrum : CRI(Ra) 80Min.

T<sub>j</sub>=85°C I<sub>f</sub>=900mA

## Reliability Tests and Results

Test	Reference Standard	Test Conditions	Test Duration	Units Failed/Tested
Temperature Cycle	JEITA ED-4701 100 105 or MIL-STD-202G	-40°C(30min)↔ 25°C(5min)↔ 100°C(30min)↔ 25°C(5min)or -40°C(30min)↔ 100°C(30min)	100cycles	0/10
High Temperature Storage	JEITA ED-4701 200 201	T <sub>A</sub> =90°C	1000hours	0/10
High Temperature Humidity Storage	JEITA ED-4701 100 103	T <sub>A</sub> =85°C RH=90%	1000hours	0/10
Low Temperature Storage	JEITA ED-4701 200 202	T <sub>A</sub> =-40°C	1000hours	0/10
High Temperature Operating Life	JESD22-A108D	TC=85°C I <sub>F</sub> =900mA	1000hours	0/10
Electrostatic Discharges	JEITA ED-4701 300 304	HBM 2KV 3KΩ 100Pf 3pulses nedative		0/10
Temperature Cycle *1	Sunpu-opto	-40°C(30min)↔ (90s)↔110°C (30min)↔(90s) -40°C	300cycles	0/10
Temperature Humidity Storage*2	Sunpu-opto	T <sub>A</sub> =85°C RH=85% I <sub>F</sub> =900mA	1000hours	0/10

**NOTES:**

Measurements are performed after allowing the LEDs to return to room temperature Failure Criteria.

Items	Conditions	Failure Criteria
Forward Voltage (VF)	$I_F=900\text{mA}$	>Initial value x 1.1
Luminous Flux ( $\Phi_V$ )	$I_F=900\text{mA}$	<Initial value x 0.7

## Packaging

100PCS

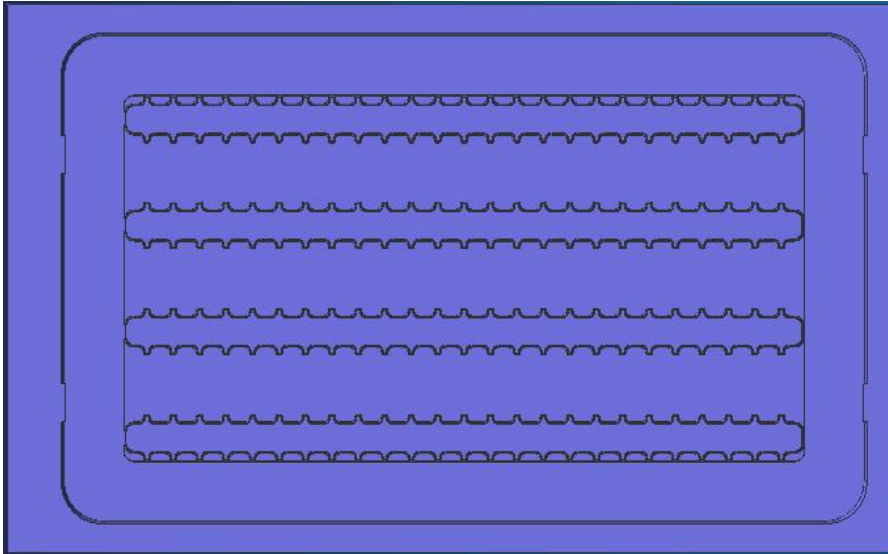

## Label instructions



**升谱光电**  
SUNPU OPTO

Lot No: 81307075001

P/N: SPC-NWW3.6-400C1

Rank: ANSI- B2/W30III/Ra80

Q' ty: 0.03kpcs QC:     

Date: 2013-08-05

Explain: 0)Lot No:

Product batch numbe

1)P/N: Product model

2)Rank: "Colorstandard"-  
"Brightnesscode"/  
"Color coordinate  
code"/"Ra"

3)Q,ty: Product  
quantity

4)QC: Qc inspection

5)Date: The date of  
productio



## Using and attention

### ■ Soldering

COB light source device is a very fragile encapsulation device. Careless in the process of soldering operation will cause the damage of the products easily and even lead to death lamp. client should be cautious. In the process of soldering iron or other welding equipment to heat up, please don't use hand or other items to put any pressure on the surface of a product, please avoid iron touch within white rubber dam. because under the white dam it is likely to be the gold thread connection with substrate. If it is extruded by any external things, it is likely cause that connections between gold wire and substrate loose or fall off leading to product stroboscopic at work or death lamp. soldering temperature shall not be higher than 350 °C and the time shall not be more than 3 seconds and the number less than 2 times. When the soldering operation is completed, it is necessary that the product is cooled to room temperature, then washed again, and other operations.

### ■ Cleaning

After soldering it is recommended that client should use alcohol to clean, The specific method is that Using tweezers clamping alcohol cotton ball in the source surface lightly wipe back and forth to clean, Prohibit the forceps tip injury to the source surface. Before using other similar solvent cleaning, please make sure that to use the solvent will not damage the product packaging materials such as silica gel and phosphor etc.

### ■ Storage

This product use sealed moisture-proof anti-static bag packaging, storage method is as follows:

- Opened before, the product must be stored in room temperature and humidity environment is not higher than 70% RH.
- Once opened, the product can be stored in room temperature and humidity is not higher than 70% RH of the environment in a week, please use in the period of time.
- If not timely installation after opening, Should be stored in dry cabinet temperature and humidity not higher than 10%RH .

### ■ Static electricity

Static and surge can cause product characteristics change, such as forward voltage to reduce, if severe cases may even damage the product. So When in use effective anti-static measures must be taken. All related equipment and machines should be properly grounded, at the same time must take other measures to prevent static and surge. Use anti-static bracelet, anti-static MATS, anti-static overalls, work shoes, gloves, anti-static container, are effective measures to prevent static and surge.

### ■ Driving and cooling scheme

In the design of driving, by the current cannot exceed a maximum value specified products. Over voltage, over current pulses generated at the moment of the power switch or reverse voltage pulse may cause product damage and even death light. Therefore it is recommended that choose drive power selection of high stability. Because the heat this for product is concentrated, It should be the choice of high thermal conductivity thermal grease or conductive adhesive and Evenly coated on the light back. There can be no gap between substrate and radiator.

### ■ Sulfidizing

The surface of the metal line material of this product is metal silver. As we all known silver and sulfur reaction generated black sulfide silver  $\text{Ag}_2\text{S}$  extremely easily, cause

substrate silver coating color, color temperature drift and light failure, greatly influence the product performance. In use process, the customer shall not use sulfur content is higher than 0.5% of the material. Common sulfide materials are:

- Production materials: carton/leather, flux, rubber, rubber gloves/sulfur gloves and other rubber materials, etc.
- Lamps and lanterns material: PCB, rubber gasket, sealing glue, and potting glue, insulating sleeve with sulphur, sulphur lamp shell, etc.

#### ■ Halogen

Halogen will damage the product, affecting device performance. Reference standards such as IEC, IPC and JPCA - ES, customers to use material, each kind of halogen content shall not be higher than 900 PPM, halogen sum shall not be higher than 1500 PPM.

- halogen include: F, Cl, Br, I
- common containing halogen material: white oil, pouring sealant, sealant, line insulation casing, etc.

#### ■ External force

Packaging adhesive products (including the white dam colloid) is fragile , when in use should pay attention to the following points:

- Do not use hard, sharp objects scratch, wipe the packaging adhesive part.
- Do not hand take products, avoid pollution package silica surface, and influence its optical properties.
- It should be noted that when using tweezers clip excessive pressure may damage , packaging silica gel,for example, damage, scratches, peeling,serious deformation and die lamp.
- Products dropped, the product may lead to deformation.