



Features:

- Industrial standard size.
- Low current operation.
- Easy mounting on P.C. boards or sockets.
- I.C. compatible.
- Mechanically rugged.
- Pb free.
- RoHS compliant.

Descriptions:

- The NES-391xAx series is a large 9.9mm (0.39”) high seven segment display.
- These displays provide excellent reliability in bright ambient light.
- These devices are made with black surface and white segments.
- The Super Bright Red source color devices are made with AlGaInP Red Light Emitting Diod



Package Dimensions & Internal Circuit Diagram

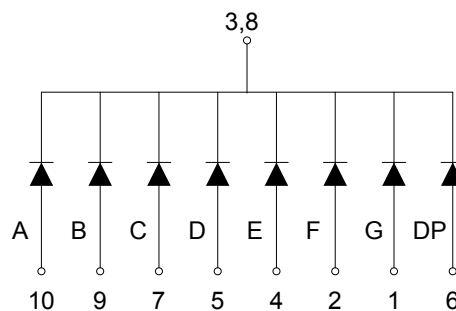
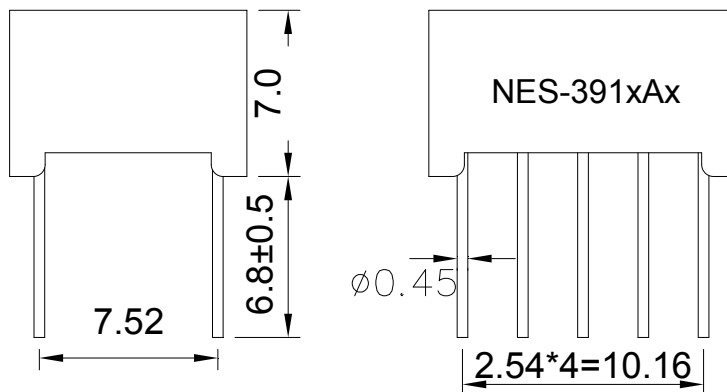
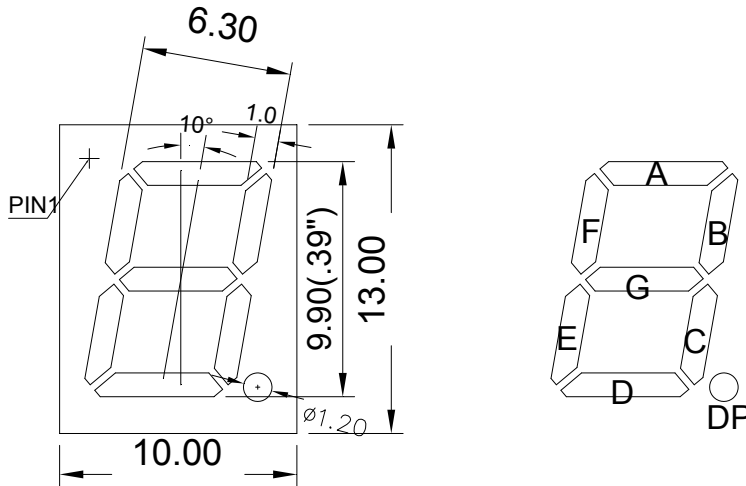

Notes:

1. All dimensions are in millimeters(inches),Tolerance is ± 0.25 (0.01") unless otherwise noted.
2. Specifications are subject to change without notice.

**Absolute maximum ratings (Ta = 25°C)**

Parameter	Symbol		Value		Unit
			Min.	Max.	
Reverse Voltage	V _R	----	----	5	V
Forward Current	I _F	----	----	25	mA
Power Dissipation	P _d	----	----	60	mW
Pulse Current	I _{peak}	Duty=0.1mS, 1kHz	----	80	mA
Operating Temperature	T _{opr}	----	-25	+85	°C
Storage Temperature	T _{str}	----	-30	+85	°C
Solder Temperature	T _{sol}	1/16inch below Seating plane	260/3		°C/s

Electrical and optical characteristics (Ta = 25°C)

Parameter	Symbol	Test Condition	Values			Unit
			Min.	Typ.	Max.	
Forward Voltage	V _F	I _F =20mA	----	1.9	2.3	V
Reverse Current	I _R	V _R =5V	----	----	30	μA
Dominate Wavelength	λ _d	I _F =20mA	----	640	----	nm
Peak Wavelength	λ _p	I _F =20mA	----	660	----	nm
Spectral Line half-width	Δλ	I _F =20mA	----	20	----	nm
Luminous Intensity	I _v	I _F =10mA	----	6000	----	ucd



Typical electrical/optical characteristic curves:

