



新品承认书

NEW PRODUCT APPROVED

客户名称 (CUSTOMERS) _____

客户 P/N (CUSTOMER P/N) _____

升谱 P/N (SUNPU P/N) NEPS-5111AY-G

产品说明 (DESCRIPTION) 0.51 英寸单八 共阳 黄色显示

送样日期 (SAMPLE DATE) _____

产品说明书 Specification <input checked="" type="checkbox"/>	检验报告 INSPECTION <input type="checkbox"/>	样品 SAMPLE <input type="checkbox"/>	其它 OTHERS <input type="checkbox"/>
核准 (APPROVED BY)	审核 (CHECKED BY)	校对 (PROOFREAD BY)	制作 (PREPARED BY)

更改履历表

版本 Version	日期 date	描述	编制 Maker

客户判定结果 (CUSTOMER VERDICT)

承认(OK)

不承认(NG)

承认签名 (APPROVED BY):

承认时间 (APPROVED DATE):

改善意见 (IMPROVED ADVICE):

说明: 为了能更好的服务客户, 请及时回传以上信息

REMARK: FOR OFFERING THE BEST SERVICE TO CUSTOMER, PLEASE FAX THE DATA TO FACTORY IN TIME



1. 产品描述 DESCRIPTION:

- 灰色显示面, 白色笔段 Gray face, White Epoxy
- 共阳显示屏 Common Anode Display
- 黄色显示, Yellow Color
- 符合 RoHS 要求 RoHS Compliant

2. 产品特征 FEATURES:

- 高可靠性和高稳定性 High intensity and reliability
- 高品质、和低功耗 High quality, Low power requirement
- IC 易兼容, 易装配 IC compatible , Easy assembly
- ESD1000V

3. 产品外形尺寸 Outer Dimension:

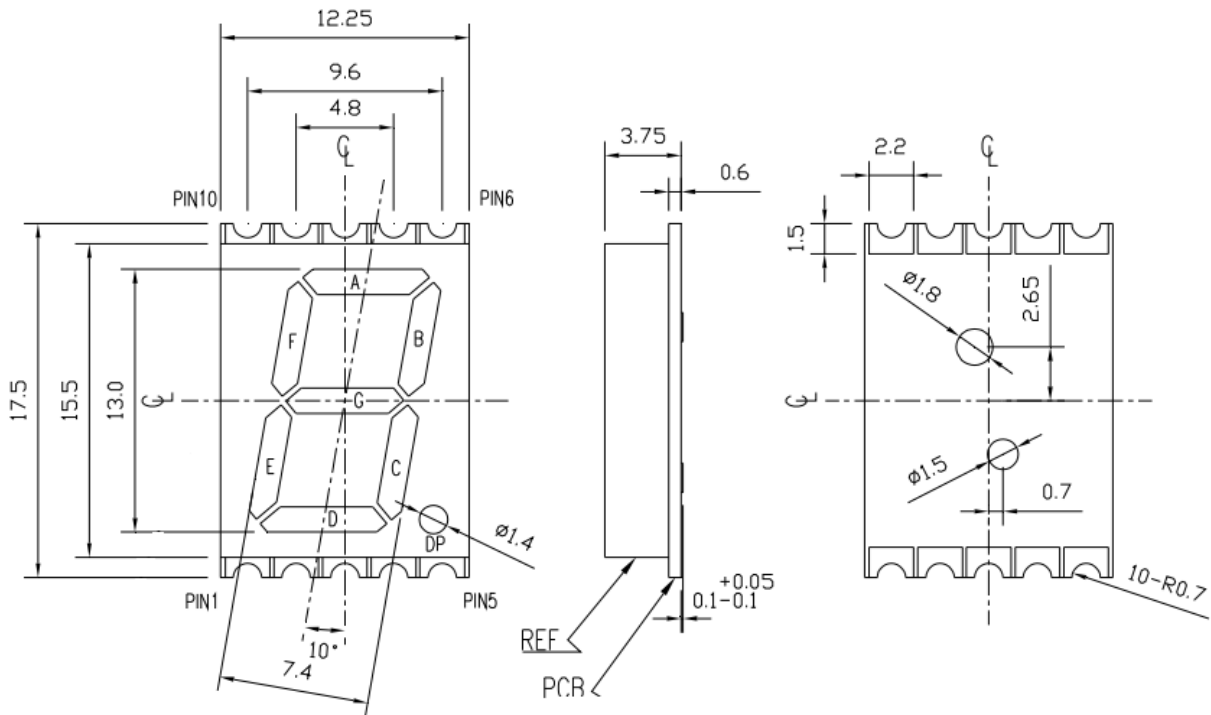

备注: 未标注公差尺寸均为±0.25mm

NOTES: All dimensions are in millimeters (inches) tolerance are ± 0.25mm(0.010) unless otherwise noted



4. 产品线路图 INTERNAL CIRCUIT DIAGRAM

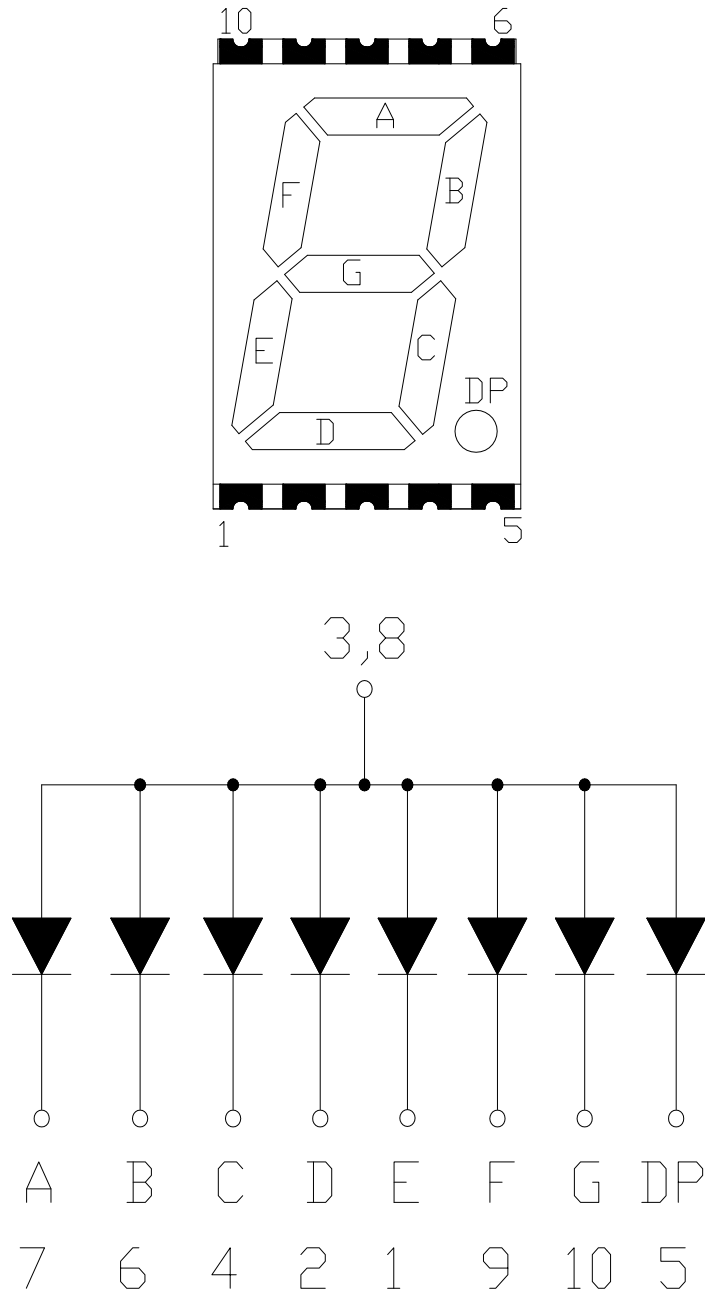



5、产品最大绝对参数值 (Ta: 25°C) ABSOLUTE MAXIMUM RATINGS AT Ta=25°C:

参数 (PARAMETER)	最大值 Max.	单位 UNIT
每段功耗 Power Dissipation Per Segment	52	mW
每段峰值电流 Peak Forward Current Per Segment (1/10duty cycle 0.1ms pulse width)	100	mA
每段平均正向电流 Average Forward Current Per Segment	20	mA
从室温线性减少 Derating Linear From 25°C Per Segment	0.33	mA/°C
每段反向电压 Reverse Voltage Per Segment	5	V
工作条件温度 Operating Temperature Range	-40°C to + 105°C	
储存温度 Storage Temperature Range	-40°C to + 105°C	
距离胶体 1.6mm 焊接, 温度 260°C, 焊接时间最多 3 秒 Lead Soldering Temperature 260°C at 1.6mm From Body for 3 seconds		

6、产品光电参数值 (Ta: 25°C) ELECTRICAL/OPTICAL CHARACTERISTICS AT Ta=25°C:

参数 PARAMETER	符号 SYMBOL	MIN.	TYP.	MAX.	UNIT	测试条件 Test condition
每段亮度 Luminous Intensity Per Segment	I_v	—	5	—	mcd	$I_F=10mA$
主波长 Dominant Wavelength	λ_d	—	590	—	nm	$I_F=20mA$
光谱半宽度 Spectral Line Half-Width	$\Delta\lambda$	—	30	—	nm	$I_F=20mA$
每颗正向电压 Forward Voltage Per Dice	V_F	—	2.0	2.6	V	$I_F=20mA$
每颗反向电流 Reverse Current Per Dice	I_R	—	—	50	μA	$V_R=5V$

7、推荐使用的焊盘尺寸 Recommended Soldering Pattern:

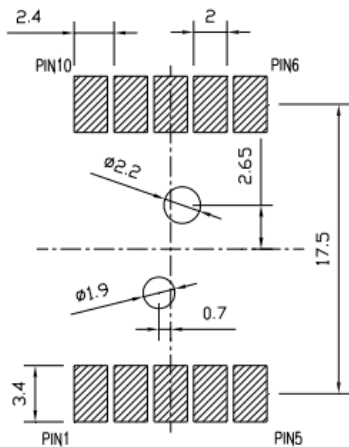



8、推荐的 SMT 焊接曲线 Recommended SMT condition:



NOTES:

1. We recommend the reflow temperature 245°C(+/-5°C). The maximum soldering temperature should be limited to 260°C.
2. Don't cause stress to the epoxy resin while it is exposed to high temperature.
3. Number of reflow process shall be 2 times or less.