



Part No.: **SPD-747D2BT-06E-Z**

样品承认书			
SPECIFICATION FOR APPROVAL			
客户名称 Customer			
送样规格 Specification		SPD-747D2BT-06E-Z	
送样日期 Deliver Date			
基本参数 Basic parameters		参见规格书	
特殊要求 Special Requirements		无	
拟制 Issued	审核 Checked	批准 Approved	客户承认盖章 Customer Approved Signatures
客户意见 Customer Feedback:			

您的宝贵意见是我们进步的源泉！ Your advices are our source of progress !

Part No.: SPD-747D2BT-06E-Z

➤ **Features/特征:**

- Photo Diode/光敏二极管
- Low power consumption/低功耗
- High reliability and long life/
可靠性高、寿命长
- RoHS compliant/符合 RoHS 标准

➤ **Descriptions/描述:**

- Device Outline/产品外形:
Special Type/ 特殊形状
- Lens Type/胶体颜色:
Black /黑色

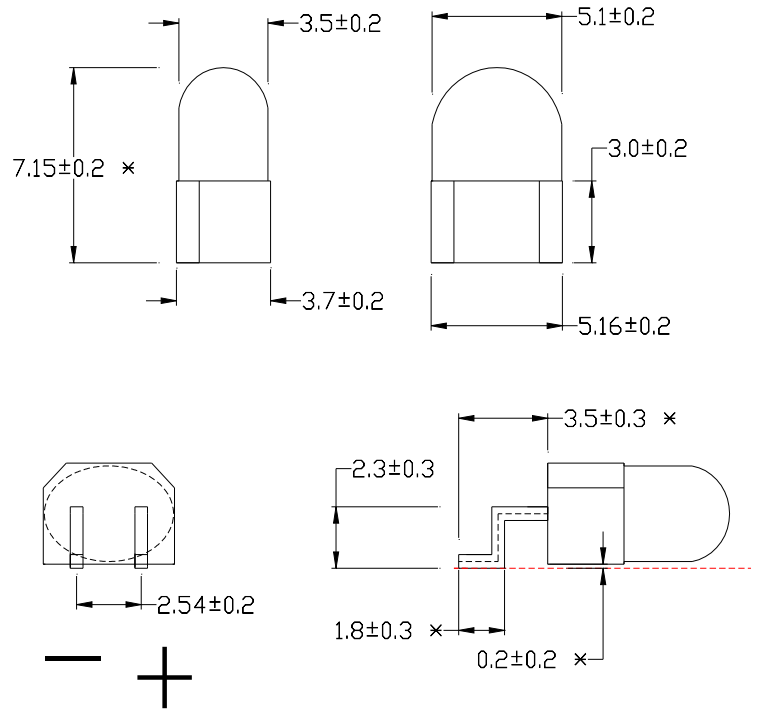

1. All dimensions are millimeters/单位: mm.
2. Tolerance is +/-0.25mm unless otherwise noted/
没有标注的公差均为±0.25mm.

**Part No.: SPD-747D2BT-06E-Z**

➤ Absolute maximum ratings/极限参数 (Ta = 25°C)

Parameter 参数	Symbol 符号	Test Condition 测试条件	Values 数值		Unit 单位
			Min.	Max.	
Operating Temperature 工作温度范围	T _{opr}	----	-40	+85	°C
Storage Temperature 储存温度范围	T _{str}	----	-40	+100	°C
Soldering Temperature 焊接温度	T _{sd}	t ≤ 10sec	----	205	°C

➤ Electrical and optical characteristics/光电参数 (Ta = 25°C)

Parameter 参数	Symbol 符号	Condition 条件	MIN. 最小	TYP. 典型	MAX. 最大	Unit 单位
Forward Voltage 正向电压	V _F	I _F = 10mA H = 0 mW/cm ²	0.5	----	1.3	V
Reverse Breakdown Voltage 崩溃电压	V _{BR}	I _R = 100 μA H = 0 mW/cm ²	35	----	----	V
Reverse Dark Current 暗电流	I _D	V _R = 10V H = 0 mW/cm ²	----	----	30	nA
Short Circuit Current 短路电流	I _{sc}	V _R = 0 H = 5mW/cm ²	----	19	----	μA
Reverse Light Current 光电流	I _L	V _R = 5V H = 1 mW/cm ²	----	40	----	μA
Turn On Time 开启时间	T _{on}	V _R = 10V R _L = 1000 Ω	----	50	----	ns
Turn Off Time 关闭时间	T _{off}	V _R = 10V R _L = 1000 Ω	----	50	----	ns
Total Capacitance 总电容	C _T	V _R = 3V F = 1MHz	----	12	----	PF

➤ Reverse Light Current Bins/光电流等级分档 (Ta = 25°C)

Min	28	35	44	55
Max	35	44	55	68

Notes/备注: Unit/单位: μA, Rank error/分档误差: I_L: ±15%



Part No.: SPD-747D2BT-06E-Z

➤ **Lead solder condition/回流焊条件:**

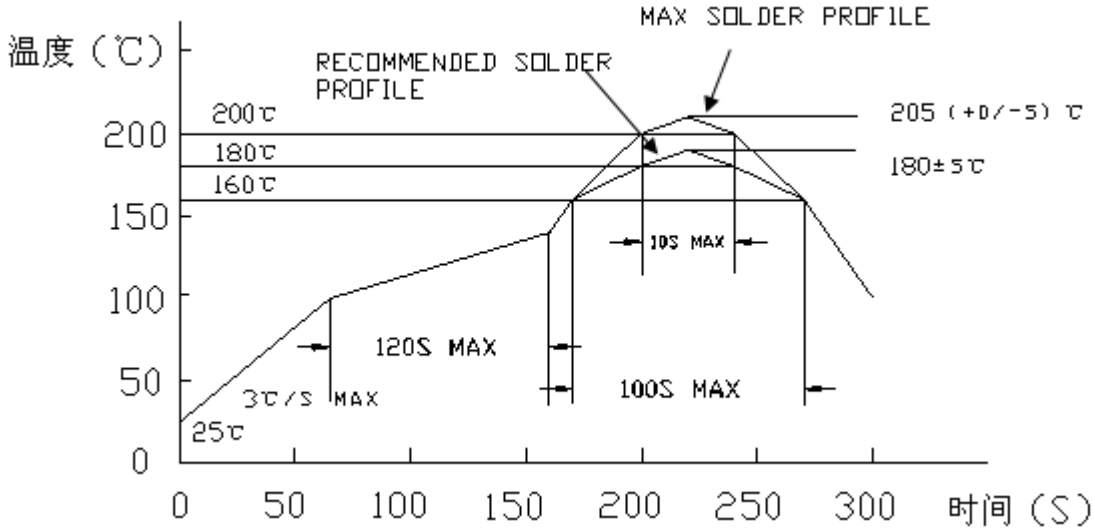

➤ **Label Form Specification/标签格式规范**

	升谱光电 SUNPU OPTO
P/N:	_____
Rank:	____ / ____ / ____
Qty:	_____ pcs
QC:	_____
Date:	_____
Lot No:	_____
 6 935056 310053 >	

P/N: Customer's Production Number/产品编号

QTY: Packing Quantity/包装数量

Ranks: Iv / Vf / WD

Iv: Iv Rank/亮度; Vf: Vf Rank/电压; WD: Color Group/色系

QC: Quality Control chapter/质量控制章

Date: mm / dd / yy

mm: Month/月; dd: Date/日; yy: Year/年;



Lot No: Production batch Number/生产批号

➤ **Cleaning/清洗**

1. Do not clean LEDs with water, Alcohol are recommended solvents for cleaning. When using other solvents, it should be confirmed beforehand whether the solvents will dissolve the resin or not.

不要用水清洗，推荐使用酒精清洗，当使用其他溶剂清洗时应事先确认该溶剂是否溶解树脂。

2. LEDs may be damaged by ultrasonic-washed. Before cleaning, a pre-test should be done to confirm whether any damage to the LEDs will occur.

LED有可能在超声波清洗过程中被破坏。为了保证安全，在清洗前，请先确认。

➤ **Storage/保存**

1. Environmental temperature: -40°C---100°C, Recommended: -20°C---50°C

环境温度：-40°C---100°C，推荐使用-20°C---50°C；

2. Environmental humidity: 30%---70%, Recommended: 40%---60%

环境湿度：30%---70%，推荐使用40%---60%；

➤ **Static Electricity/静电**

1. Static Electricity or power surge will damage the LED.

It is recommended that a wrist band or an anti-electrostatic glove be used when handling the LEDs.

静电或激增电压将损害 LED。

建议使用发光二极管时佩戴手腕带或防静电手套。

2. All production machinery and test instruments must be electrically grounded.



Part No.: SPD-747D2BT-06E-Z

所有的生产机器和检测仪器，必须接地。

3. Maintain a humidity level of 50% or higher in production areas.

生产现场湿度必须保持在50%或者更高。

➤ **Notes/备注**

1. This datasheet will be update regularly, if there comes out any changes, pls confirmed by the latest datasheet.

以上规格书会定期进行更新，如有改动,以最新规格书为准。

2. When using this product, please observe the absolute maximum ratings and the instructions for using outlined in these specification sheets. SUNPU assumes no responsibility for any damage resulting from use of the product which does not comply with the absolute maximum ratings and the instructions included in these specification sheets.

在使用本产品时，请注意参考规格书中的最大额定值和使用说明，如果没有遵照产品规格书中的最大额定值以及使用说明而产生的不良后果，不在升谱承诺范围之内。