



Part No./型号: **SIR-522F1CAB**

样品承认书

**SPECIFICATION FOR APPROVAL**

客户名称 Customer			
送样规格 Specification		SIR-522F1CAB	
送样日期 Deliver Date			
基本参数 Basic parameters		参见规格书	
特殊要求 Special Requirements		无	
拟制 Issued	审核 Checked	批准 Approved	客户承认盖章 Customer Approved Signatures
客户意见 Customer Feedback:			

您的宝贵意见是我们进步的源泉! Your advices are our source of progress!



**Part No./型号: SIR-522F1CAB**

➤ **Features/特征:**

- Infrared LED/红外二极管
- High Power output/高功率输出
- Low power consumption/低功耗
- High reliability and long life/  
可靠性高、寿命长
- RoHS compliant/符合 RoHS 标准

➤ **Descriptions/描述:**

- Die material/芯片材质: AlGaAs
- Emitting Color/发光颜色:  
Infrared Emitting diodes/发射管
- Device Outline/产品外形:  
φ 5mm Round Type/ φ 5mm 圆形
- Lens Type/胶体颜色:  
Water Clear /无色透明

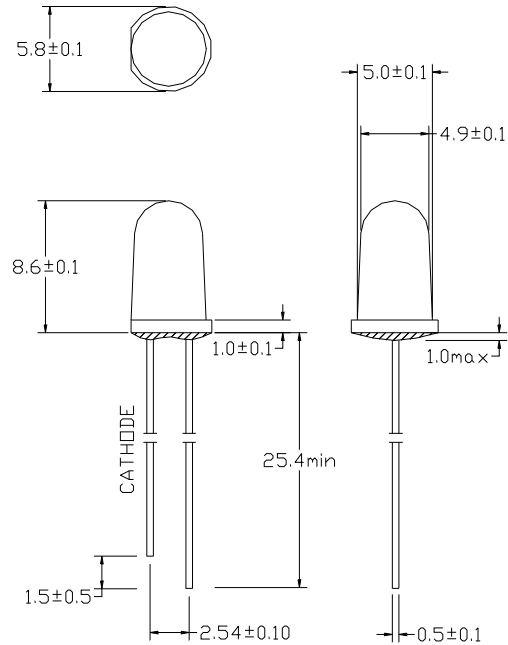

1. All dimensions are millimeters/单位: mm.
2. Tolerance is +/-0.25mm unless otherwise noted/  
没有标注的公差均为±0.25mm.

➤ **Directivity/指向特性: (Ta=25°C , IF=50mA)**

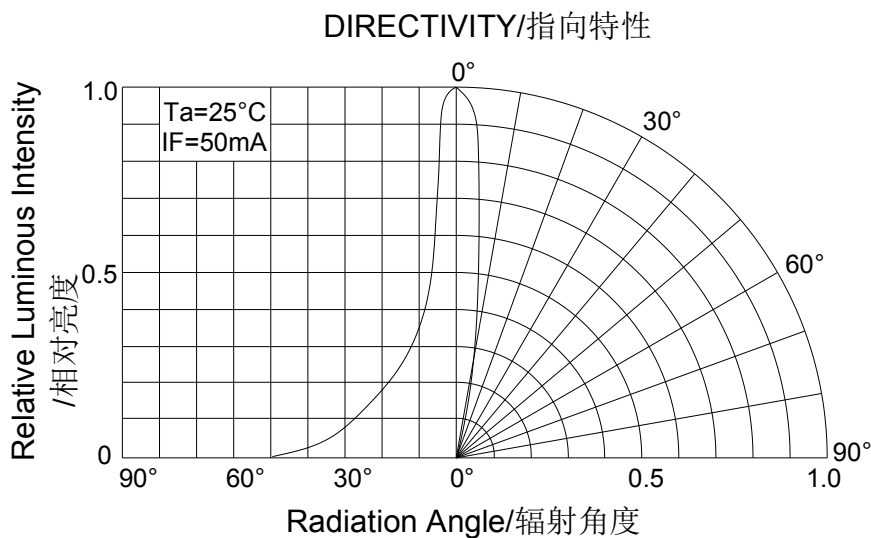

Part No./型号: **SIR-522F1CAB**➤ **Absolute maximum ratings/极限参数 (Ta = 25°C)**

Parameter 参数	Symbol 符号	Test Condition 测试条件	Values 数值		Unit 单位
			Min.	Max.	
Reverse Voltage 反向电压	VR	IR = 10 μA	5	-----	V
Power Dissipation 损耗功率	Pd	-----	-----	90	mW
<b>Pulse Current</b> 正向峰值电流	<b>Ipeak</b>	Duty=0.01mS 1kHz	-----	1000	mA
Operating Temperature 工作温度范围	Topr	-----	-40	+85	°C
Storage Temperature 储存温度范围	Tstr	-----	-40	+100	°C
Soldering Temperature 焊接温度	Tsd	t ≤ 3sec, 2mm from case	----	260	°C

➤ **Electrical and optical characteristics/光电参数 (Ta = 25°C)**

Parameter 参数	Symbol 符号	Test Condition 测试条件	Values 数值			Unit 单位
			Min.	Typ.	Max.	
Forward Voltage 正向电压	VF	IF = 50mA	----	1.5	1.8	V
Reverse Current 反向电流	IR	VR = 5V	----	----	10	μA
<b>Peak Wavelength</b> 峰值波长	$\lambda_p$	IF = 50mA	----	850	----	nm
<b>Spectral Line half-width</b> 半波长宽度	$\Delta \lambda$	IF = 50mA	----	40	----	nm
Radiant Intensity 辐射强度	Ie	IF = 50mA		150	----	mW/sr
Viewing Angle 指向角度	2θ 1/2	IF = 50mA	----	10	----	deg.



**Part No./型号: SIR-522F1CAB**

➤ **Typical electrical/optical characteristic curves/光电特性曲线:**

Fig.1 正向电流VS. 正向电压

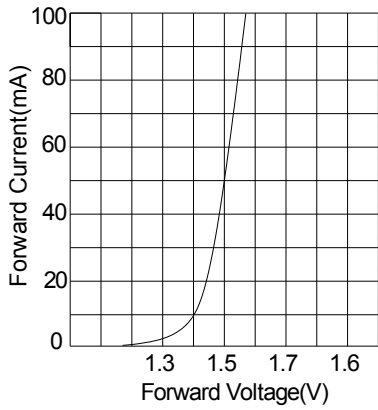

Fig.2 相对亮度VS. 正向电流

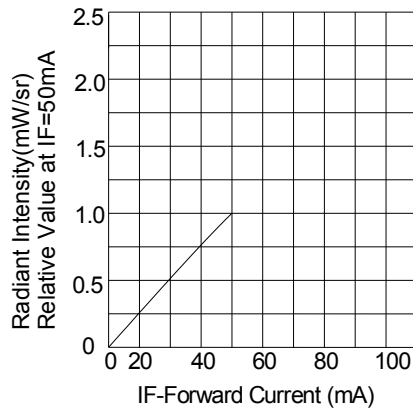

Fig.3 环境温度VS.正向电流

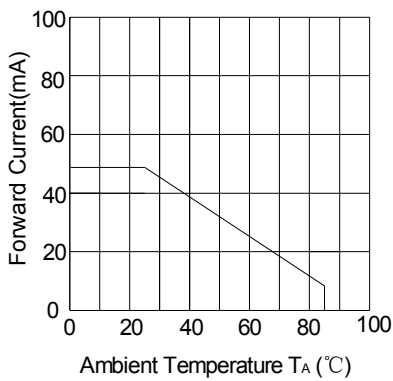

Fig.4 环境温度VS.相对亮度

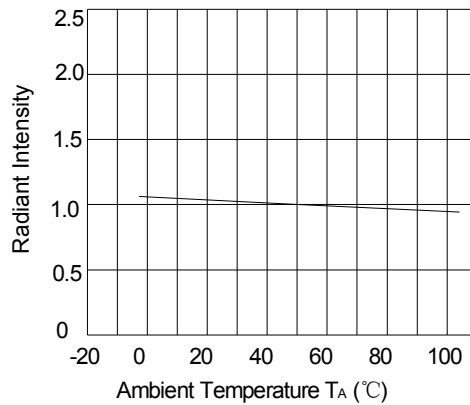
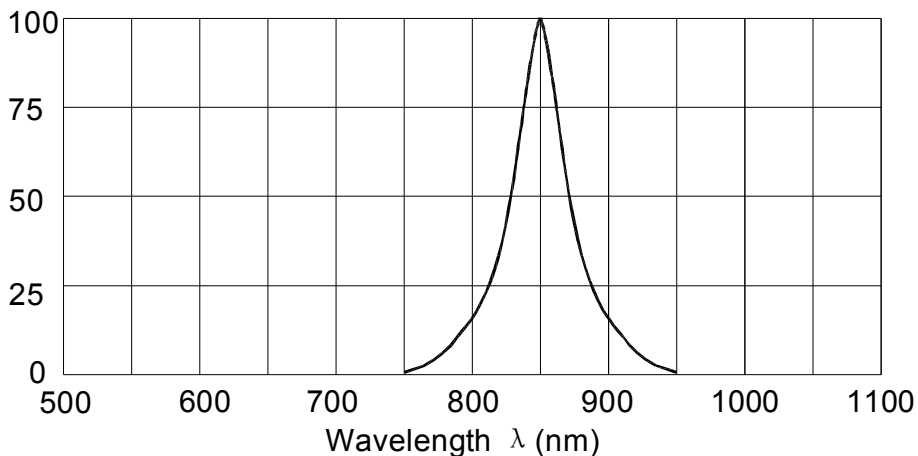

Fig.5 相对亮度VS.波长





Part No./型号: **SIR-522F1CAB**

➤ **Label Form Specification/标签格式规范**

	升谱光电 SUNPU OPTO
P/N:	_____
Rank:	____ / ____ / ____
Qty:	_____ pcs QC: ____
Date:	_____
Lot No:	_____
 6 935056 310053 >	

P/N: Customer's Production Number/产品编号

QTY: Packing Quantity/包装数量

Ranks: Iv / Vf / WD

Iv: Iv Rank/亮度; Vf: Vf Rank/电压; WD: Color Group/色系

QC: Quality Control chapter/质量控制章

Date: mm / dd / yy

mm: Month/月; dd: Date/日; yy: Year/年;

Lot No: Production batch Number/生产批号

➤ **Lead Forming/成形**

1. Any lead forming or bending must be done before soldering.

支架成形必须在焊接前完成。

2. When forming leads, there must be a minimum of 2mm clearance between the base of the LED lens and the lead bend.

必需离胶体 2 毫米才能折弯支架。



**Part No./型号: SIR-522F1CAB**

3. Avoid bending the leads at the same point more than once.

避免在管脚同一位置两次或多次弯。

4. During assembly onto PCB, the lead pitch of the LED must match the pitch of the mounting holes on the PCB during component placement.

支架成形需保证引脚和间距与线路板上一致。

5. Recommendations for manual plug-in operation, if really need taping machine for inserting operation, please make small batch prenatal confirmation.

建议手工插件作业，若确实需要编带机插作业，请进行小批量产前确认。

➤ **Soldering Condition/焊接条件**

Careful attention should be paid during soldering. When soldering, leave more than 2mm from solder joint to case, and soldering beyond the base of the tie bar is recommended.

焊接时请特别注意，焊接点要离LED封装体底部2mm以上。

Avoiding applying any stress to the lead frame while the LEDs are at high temperature particularly when soldering.

在LED处于高温，特别是在焊接时，请避免对支架施压。

**Recommended soldering conditions/推荐焊接条件:**

Hand Soldering 手工焊接		DIP Soldering 浸焊	
Temp.at tip of iron 电烙铁温度	300°C Max.(30W Max.) 最高温度300°C (功率不超过30瓦)	Preheat temp. 预热温度	100°C Max. (60 sec Max.) 最高温度100°C (不超过60秒)
Soldering time 焊接时间	3 sec Max. 时间不超过3秒	Bath temp. 浸焊温度	260°C Max 最高260°C.
Distance 焊接位置	2mm Min.(From solder joint to case) 大于2毫米 (从焊点到胶体)	Bath time. 浸焊时间	3 sec Max. 不超过3秒
		Distance 浸焊位置	2mm Min 大于2毫米.



**Part No./型号: SIR-522F1CAB**

➤ **Cleaning/清洗**

1. Do not clean LEDs with water, Alcohol are recommended solvents for cleaning. When using other solvents, it should be confirmed beforehand whether the solvents will dissolve the resin or not.

不要用水清洗，推荐使用酒精清洗，当使用其他溶剂清洗时应事先确认该溶剂是否溶解树脂。

2. LEDs may be damaged by ultrasonic-washed. Before cleaning, a pre-test should be done to confirm whether any damage to the LEDs will occur.

LED有可能在超声波清洗过程中被破坏。为了保证安全，在清洗前，请先确认。

➤ **Storage/保存**

1. Environmental temperature:  $-40^{\circ}\text{C}$ --- $100^{\circ}\text{C}$ , Recommended:  $-20^{\circ}\text{C}$ --- $50^{\circ}\text{C}$

环境温度： $-40^{\circ}\text{C}$ --- $100^{\circ}\text{C}$ ，推荐使用 $-20^{\circ}\text{C}$ --- $50^{\circ}\text{C}$ ；

2. Environmental humidity: 30%---70%, Recommended: 40%---60%

环境湿度：30%---70%，推荐使用40%---60%；

➤ **Static Electricity/静电**

1. Static Electricity or power surge will damage the LED.

It is recommended that a wrist band or an anti-electrostatic glove be used when handling the LEDs.

静电或激增电压将损害 LED。

建议使用发光二极管时佩戴手腕带或防静电手套。

2. All production machinery and test instruments must be electrically grounded.

所有的生产机器和检测仪器，必须接地。



**Part No./型号: SIR-522F1CAB**

3. Maintain a humidity level of 50% or higher in production areas.

生产现场湿度必须保持在50%或者更高。

4. Use anti-static packaging for transport and storage.

使用防静电包装，运输和储存。

➤ **Notes/备注**

1. This datasheet will be update regularly, if there comes out any changes, pls confirmed by the latest datasheet.

以上规格书会定期进行更新，如有改动,以最新规格书为准。

2. When using this product, please observe the absolute maximum ratings and the instructions for using outlined in these specification sheets. SUNPU assumes no responsibility for any damage resulting from use of the product which does not comply with the absolute maximum ratings and the instructions included in these specification sheets.

在使用本产品时，请注意参考规格书中的最大额定值和使用说明，如果没有遵照产品规格书中的最大额定值以及使用说明而产生的不良后果，不在升谱承诺范围之内。