

Supplier name:
Ningbo Sunpu Led Co.,Ltd.,

Acknowledgment number:

Product Acknowledgment

Customer Name:

Supply-side model:

Acknowledgment Effective Date:

| Manufacturers | | Client Confirm (Quality) | | Client Confirm (R & D) | |
|---------------|--|--------------------------------------|--|--------------------------------------|--|
| Prepared | | Qualified <input type="checkbox"/> | | Qualified <input type="checkbox"/> | |
| | | Unqualified <input type="checkbox"/> | | Unqualified <input type="checkbox"/> | |
| Audit | | Audit | | Audit | |
| Approve | | Approve | | Approve | |

(After both sides confirmed the Acknowledgment qualified,must be signed and sealed)

Supply-side Address: No 150.XinHui Road, Hi-Tech Park,Ningbo,china

Tel: 0574-87740939



COB-G7 series

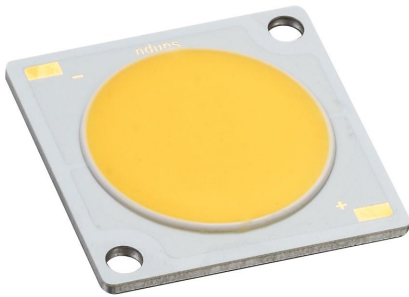

Product introduction

The series of products ,which use mirror aluminum for substrate.The products have high brightness, long life, a variety of power, easy installation, general size, which are especially suitable for indoor and outdoor lighting products, etc.

Features:

- ✧ High brightness、high reliability、long life
- ✧ Light angle: 120°
- ✧ Typical color temperature:
6500K/5000K/4000K/3500K/3000K/2700K
- ✧ Ra : 80+
- ✧ Through the LM-80 certification
- ✧ In line with the EU ROHS standard

Contents

| | |
|--------------------------------------|----|
| Outline dimensions | 3 |
| Circuit structure..... | 3 |
| Limit parameter | 3 |
| Photoelectric parameters | 4 |
| Typical curve | 6 |
| Chromaticity Coordinates Ranks | 7 |
| Reliability test and results..... | 9 |
| Packaging | 10 |
| Using and attention | 11 |
| Model naming rules..... | 11 |

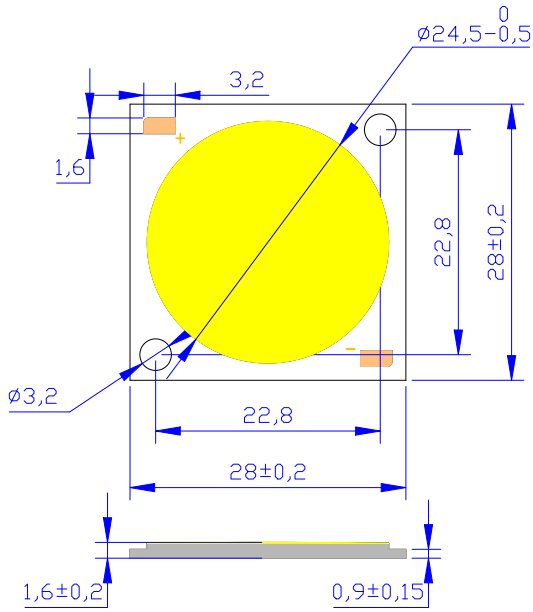
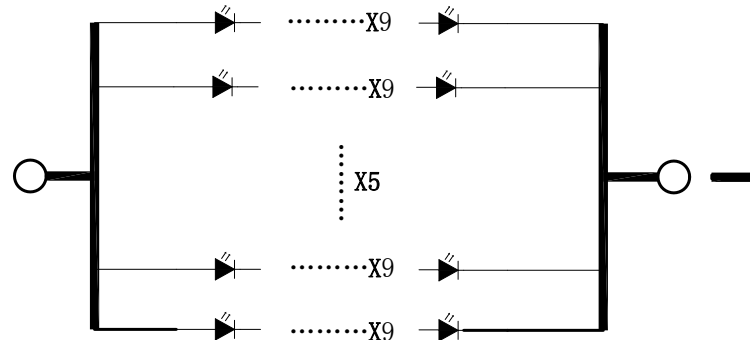
Part No.: G7-XXXH0509-2314MX
Outline dimensions

Circuit structure

NOTES:

- ◇ All dimensions are millimeter.
- ◇ Tolerance is $\pm 0.3\text{mm}$ unless otherwise noted.
- ◇ It is strongly recommended that the temperature of T_s (Welding plate) is not higher than 90°C .

Limit parameter ($T_a = 25^\circ\text{C}$)

| Parameter | Symbol | Test Condition | Value | | Unit |
|--------------------------|-------------------|----------------|--|-------|------------------|
| | | | Min. | Max. | |
| DC Forward Current | I_F | ---- | ---- | 750 | mA |
| Peak Pulse Current | I_{peak} | Duty=1/10 1kHz | ---- | 938 | mA |
| Power Dissipation | P_d | ---- | ---- | 14.85 | W |
| LED Junction Temperature | T_j | ---- | ---- | 125 | $^\circ\text{C}$ |
| Operating Temperature | T_{opr} | ---- | -40 | +85 | $^\circ\text{C}$ |
| Storage Temperature | T_{str} | ---- | -40 | +100 | $^\circ\text{C}$ |
| ESD Sensitivity | ---- | HBM | 2000 | ---- | V |
| Soldering Temperature | ---- | ---- | 350 $^\circ\text{C}$ for 5 Seconds max | | |

Part No.: G7-XXXH0509-2314MX
Photoelectric parameters (Ta = 25°C)

| ITEMS | | Parameter | Symbol | Test Condition | Min | Typ | Max | Unit |
|------------------------|-------------------|--------------------|------------------------|------------------------|------|------|------|------|
| 2700-6500K ANSI/IEC | | Forward Voltage | V _F | I _F = 500mA | -- | 27 | -- | V |
| | | Color Rendening | R _a | | 80 | -- | -- | |
| | | Thermal Resistance | R _J | | -- | 1.6 | -- | °C/W |
| ANSI | 2700K | Color Temperature | CCT | I _F = 500mA | 2650 | 2725 | 2800 | K |
| | | Luminous Flux | Φ _v | | -- | 1450 | -- | lm |
| | 3000K | Color Temperature | CCT | | 2970 | 3045 | 3120 | K |
| | | Luminous Flux | Φ _v | | -- | 1515 | -- | lm |
| | 3500K | Color Temperature | CCT | | 3350 | 3465 | 3580 | K |
| | | Luminous Flux | Φ _v | | -- | 1580 | -- | lm |
| | 4000K | Color Temperature | CCT | | 3850 | 3985 | 4125 | K |
| | | Luminous Flux | Φ _v | | -- | 1640 | -- | lm |
| | 5000K | Color Temperature | CCT | | 4850 | 5030 | 5210 | K |
| | | Luminous Flux | Φ _v | | -- | 1640 | -- | lm |
| | 6500K | Color Temperature | CCT | | 6190 | 6530 | 6910 | K |
| | | Luminous Flux | Φ _v | | -- | 1640 | -- | lm |
| IEC | 2700K | Color Temperature | CCT | I _F = 500mA | 2650 | 2725 | 2800 | K |
| | | Luminous Flux | Φ _v | | -- | 1450 | -- | lm |
| | 3000K | Color Temperature | CCT | | 2850 | 2940 | 3030 | K |
| | | Luminous Flux | Φ _v | | -- | 1515 | -- | lm |
| | 3500K | Color Temperature | CCT | | 3340 | 3450 | 3560 | K |
| | | Luminous Flux | Φ _v | | -- | 1580 | -- | lm |
| | 4000K | Color Temperature | CCT | | 3850 | 3985 | 4125 | K |
| | | Luminous Flux | Φ _v | | -- | 1640 | -- | lm |
| | 5000K | Color Temperature | CCT | | 4820 | 5000 | 5180 | K |
| | | Luminous Flux | Φ _v | | -- | 1640 | -- | lm |
| | 6500K | Color Temperature | CCT | | 6190 | 6530 | 6910 | K |
| | | Luminous Flux | Φ _v | | -- | 1640 | -- | lm |
| SUNPU 6000K | Color Temperature | CCT | I _F = 500mA | 5720 | 6000 | 6350 | K | |
| | Luminous Flux | Φ _v | | -- | 1640 | -- | lm | |

Part No.: G7-XXXH0509-2314MX

Typical curves:

Fig.1 Forward Current (mA) Vs Forward Voltage (V)

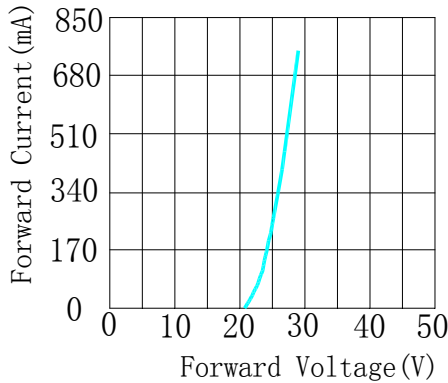

Fig.2 Relative Intensity Vs Forward Current (mA)

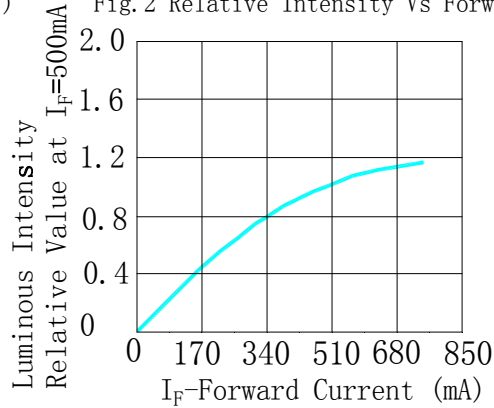

Fig.3 Forward Current Vs Ambient Temperature

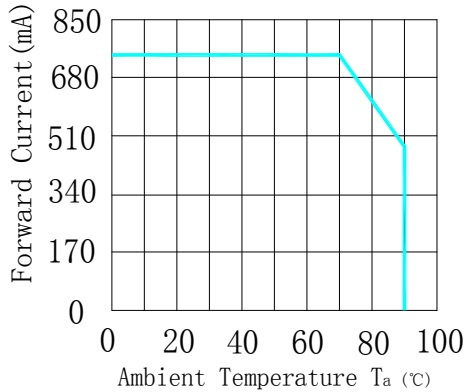
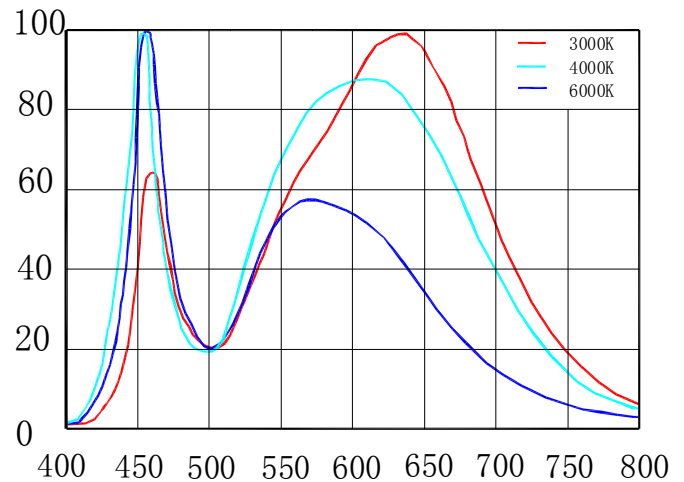
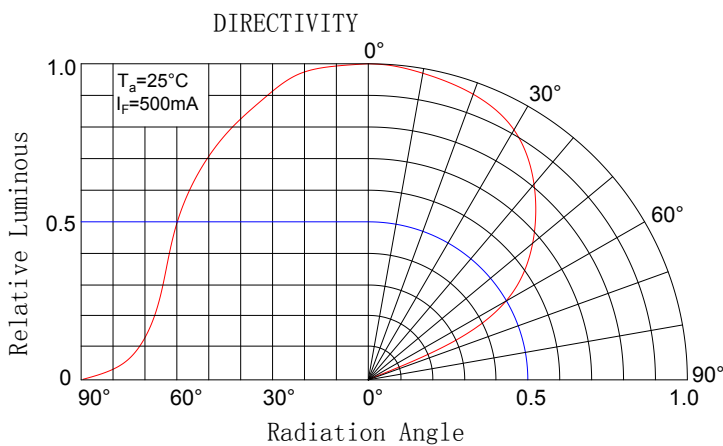
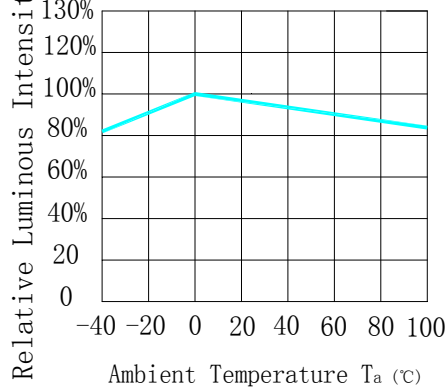
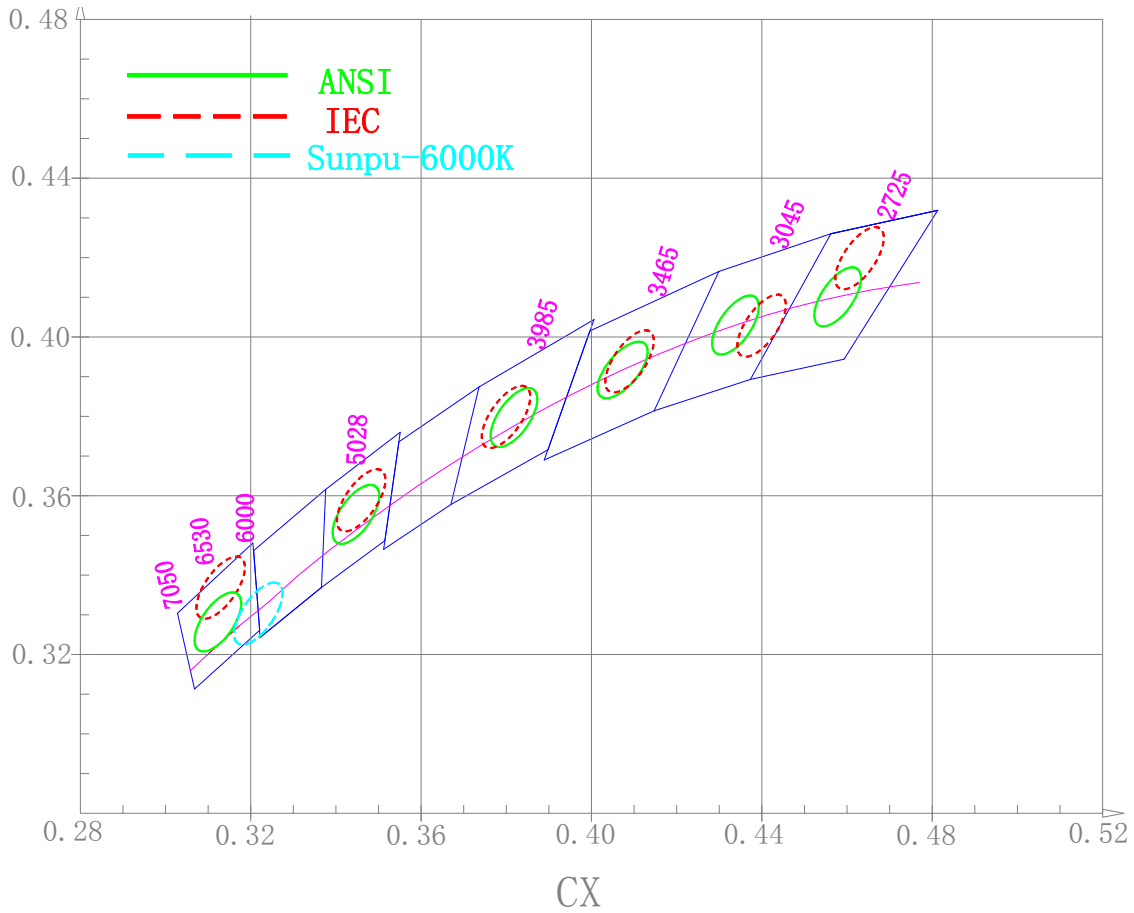

Fig.4 Relative Intensity Vs Ambient Temperature



Part No.: G7-XXXH0509-2314MX

Chromaticity Coordinates Ranks(I_F=500mA Ta=25°C)



Part No.: G7-XXXH0509-2314MX

| Stands | Colour temperature | Center of Coordinates | | Long axis | Minor axis | Gradient | Explain |
|-------------|--------------------|-----------------------|--------|-----------|------------|----------|----------------|
| | | X | Y | | | | |
| ANSI | TC | X | Y | a | b | θ | SDCM |
| | 6500K | 0.3123 | 0.3282 | 0.00892 | 0.0038 | 58.23 | 4-step MacAdam |
| | 5000K | 0.3447 | 0.3553 | 0.00822 | 0.00354 | 59.62 | 3-step MacAdam |
| | 4000K | 0.3818 | 0.3797 | 0.00939 | 0.00402 | 53.72 | |
| | 3500K | 0.4073 | 0.3917 | 0.00951 | 0.00417 | 52.58 | |
| | 3000K | 0.4338 | 0.403 | 0.00714 | 0.00408 | 53.22 | |
| | 2700K | 0.4578 | 0.4101 | 0.00774 | 0.00411 | 53.7 | |
| IEC | 6500K | 0.3130 | 0.3370 | 0.00892 | 0.0038 | 58.23 | 4-step MacAdam |
| | 5000K | 0.3460 | 0.3590 | 0.00822 | 0.00354 | 59.62 | 3-step MacAdam |
| | 4000K | 0.3800 | 0.3800 | 0.00939 | 0.00402 | 53.72 | |
| | 3500K | 0.4090 | 0.3940 | 0.00951 | 0.00417 | 52.58 | |
| | 3000K | 0.4400 | 0.4030 | 0.00714 | 0.00408 | 53.22 | |
| | 2700K | 0.4630 | 0.4200 | 0.00774 | 0.00411 | 53.7 | |
| Sunpu-6000K | 6000K | 0.3217 | 0.3303 | 0.00892 | 0.0038 | 58.23 | 4-step MacAdam |

| Code | Colour temperature |
|------|--------------------|
| W27 | 2700K |
| W30 | 3000K |
| W35 | 3500K |
| W40 | 4000K |
| W50 | 5000K |
| W60 | 6000K |
| W65 | 6500K |

Notes:

- ✧ Our company deliver according to the 3 order macadam ellipses among 2700K-5000K and deliver the 4 order macadam ellipses among 6000K-6500K for above 3 stands.
- ✧ Tolerance of measurements of the Forward Voltage is $\pm 2\%V$
- ✧ Tolerance of measurements of the Luminous Flux is $\pm 10\%$
- ✧ Tolerance of measurements of the Color Rendering R_a is ± 2
- ✧ Chromaticity Coordinates (x,y) is measured with an accuracy of ± 0.01
- ✧ The center of Coordinates (x,y) is based on C78.377:2008 ANSI reference
- ✧ Ellipse refer to IEC 60081:1997
- ✧ Ranking at $T_c=25^\circ C$

Part No.: G7-XXXH0509-2314MX

| BIN | Luminous Flux (lm) | BIN | Luminous Flux (lm) |
|-----|--------------------|-----|--------------------|
| A | 0-5 | R2 | 3000-3500 |
| B | 5-10 | S2 | 3500-4000 |
| C | 10-15 | T2 | 4000-4500 |
| D | 15-20 | U2 | 4500-5000 |
| E | 20-25 | V2 | 5000-5500 |
| F | 25-30 | W2 | 5500-6000 |
| G | 30-35 | X2 | 6000-6500 |
| H | 35-40 | Y2 | 6500-7000 |
| J | 40-50 | Z2 | 7000-7500 |
| K | 50-60 | A3 | 7500-8000 |
| L | 60-80 | B3 | 8000-8500 |
| M | 80-100 | C3 | 8500-9000 |
| N | 100-120 | D3 | 9000-9500 |
| P | 120-140 | E3 | 9500-10000 |
| Q | 140-160 | F3 | 10000-10500 |
| R | 160-180 | G3 | 10500-11000 |
| S | 180-200 | H3 | 11000-11500 |
| T | 200-240 | J3 | 11500-12000 |
| U | 240-280 | K3 | 12000-12500 |
| V | 280-320 | L3 | 12500-13000 |
| W | 320-360 | M3 | 13000-13500 |
| X | 360-400 | N3 | 13500-14000 |
| Y | 400-450 | P3 | 14000-14500 |
| Z | 450-500 | Q3 | 14500-15000 |
| A2 | 500-600 | R3 | 15000-15500 |
| B2 | 600-700 | S3 | 15500-16000 |
| C2 | 700-800 | T3 | 16000-16500 |
| D2 | 800-900 | U3 | 16500-17000 |
| E2 | 900-1000 | V3 | 17000-17500 |
| F2 | 1000-1200 | W3 | 17500-18000 |
| G2 | 1200-1400 | X3 | 18000-18500 |
| H2 | 1400-1600 | Y3 | 18500-19000 |
| J2 | 1600-1800 | Z3 | 19000-19500 |
| K2 | 1800-2000 | A4 | 19500-20000 |
| L2 | 2000-2200 | B4 | 20000-20500 |
| M2 | 2200-2400 | C4 | 20500-21000 |
| N2 | 2400-2600 | D4 | 21000-21500 |
| P2 | 2600-2800 | E4 | 21500-22000 |
| Q2 | 2800-3000 | F4 | 22000-22500 |

Part No.: G7-XXXH0509-2314MX
Reliability Tests and Results

| Test | Reference Standard | Test Conditions | Test Duration | Units Failed/ Tested |
|-----------------------------------|---|---|---------------|----------------------|
| Temperature Cycle | JEITA ED-4701 100 105 or MIL-STD-202 G | -40°C (30min) ∼ 25°C (5min) ∼ 10 0°C (30min) ∼ 25°C (5min) or -40°C (30min) ∼ 100°C (30min) | 100cycles | 0/10 |
| High Temperature Storage | JEITA ED-4701 200 201 | T _A =90°C | 1000hours | 0/10 |
| High Temperature Humidity Storage | JEITA ED-4701 100 103 | T _A =85°C RH=90% | 1000hours | 0/10 |
| Low Temperature Storage | JEITA ED-4701 200 202 | T _A =-40°C | 1000hours | 0/10 |
| High Temperature Operating Life | JESD22-A108D | TC=85°C I _F =750mA | 1000hours | 0/10 |
| Electrostatic Discharges | JEITA ED-4701 300 304 | HBM 2KV 3KΩ 100Pf 3pulses negative | | 0/10 |
| Temperature Cycle *1 | Sunpu-opto | -40°C (30min) ∼ (90s) ∼ 110°C (30min) ∼ (90s) -40°C | 300cycles | 0/10 |
| Temperature Humidity Storage*2 | Sunpu-opto | T _A =85°C RH=85% I _F =500mA | 1000hours | 0/10 |

NOTES:

* Measurements are performed after allowing the LEDs to return to room temperature

Failure Criteria

| Items | Conditions | Failure Criteria |
|----------------------|-----------------------|----------------------|
| Forward Voltage (VF) | I _F =500mA | >Initial value x 1.1 |
| Luminous Flux (ΦV) | I _F =500mA | <Initial value x 0.7 |

Part No.: G7-XXXH0509-2314MX

Packaging

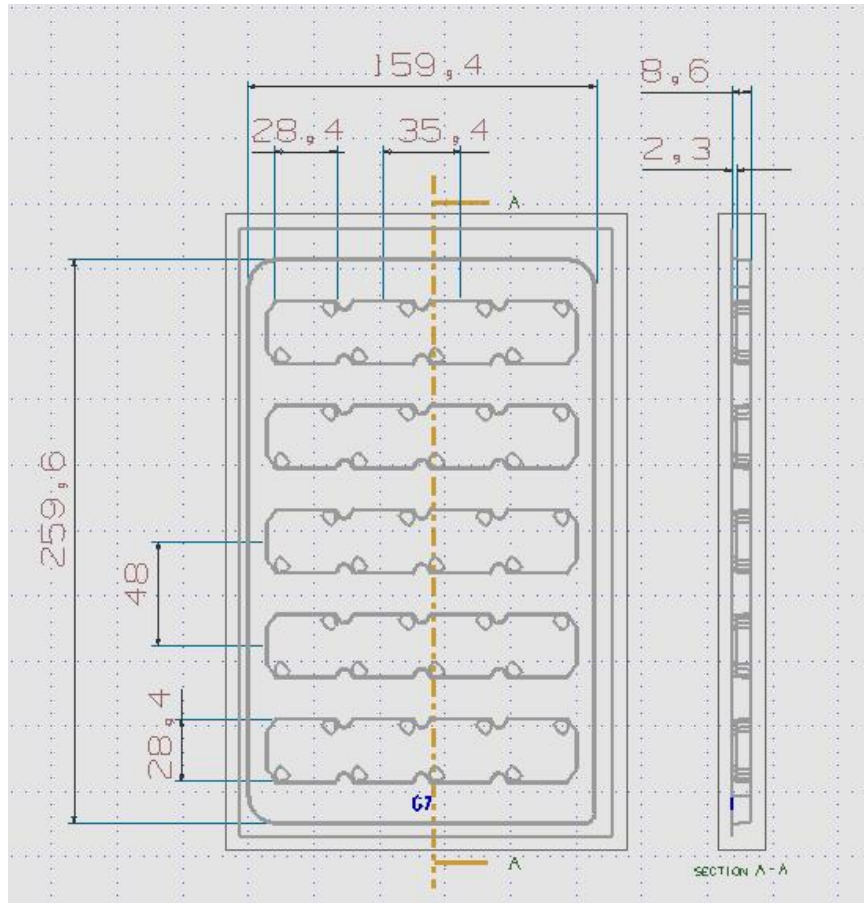

20PCS for each layer

Label instructions



Lot No: 81307075001
 P/N: SPC-NWW3.6-400C1
 Rank: ANSI- B2/W30III/Ra80
 Q' ty: 0.03kpcs QC: _____
 Date: 2013-08-05

- Explain:
- 0) Lot No: Product batch number
 - 1) P/N: Product model
 - 2) Rank: "Color standard" - "Brightness code"
/ "Color coordinate code" / "Ra"
 - 3) Q,ty: Product quantity
 - 4) QC: Qc inspection
 - 5) Date: The date of production

Part No.: G7-XXXH0509-2314MX

Using and attention

1、 Soldering

COB light source device is a very fragile encapsulation device. Careless in the process of soldering operation will cause the damage of the products easily and even lead to death lamp. client should be cautious. In the process of soldering iron or other welding equipment to heat up, please don't use hand or other items to put any pressure on the surface of a product, please avoid iron touch within white rubber dam. because under the white dam it is likely to be the gold thread connection with substrate. If it is extruded by any external things, it is likely cause that connections between gold wire and substrate loose or fall off leading to product stroboscopic at work or death lamp. soldering temperature shall not be higher than 350 °C and the time shall not be more than 3 seconds and the number less than 2 times. When the soldering operation is completed , it is necessary that the product is cooled to room temperature, then washed again, and other operations.



2、 Cleaning

After soldering it is recommended that client should use alcohol to clean, The specific method is that Using tweezers clamping alcohol cotton ball in the source surface lightly wipe back and forth to clean,

Part No.: G7-XXXH0509-2314MX

Prohibit the forceps tip injury to the source surface .Before using other similar solvent cleaning, please make sure that to use the solvent will not damage the product packaging materials such as silica gel and phosphor etc.

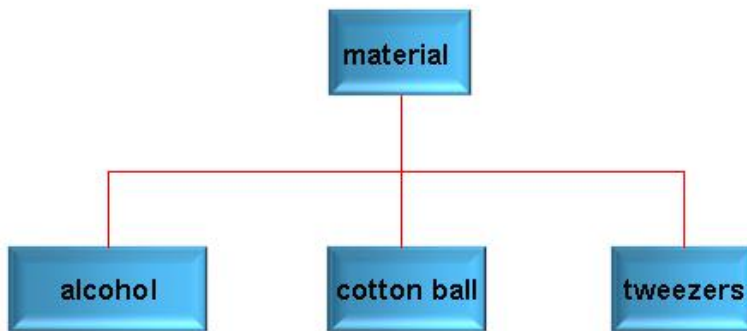

3、 Storage

This product use sealed moisture-proof anti-static bag packaging, storage method is as follows:

- ✧ Opened before, the product must be stored in room temperature and humidity environment is not higher than 70% RH.
- ✧ Once opened, the product can be stored in room temperature and humidity is not higher than 70% RH of the environment in a week, please use in the period of time.

If not timely installation after opening, Should be stored in dry cabinet temperature and humidity not higher than 10%RH .

4、 Static electricity

Static and surge can cause product characteristics change, such as forward voltage to reduce, if severe cases may even damage the product. So When in use effective anti-static measures must be taken. All

Part No.: G7-XXXH0509-2314MX

related equipment and machines should be properly grounded, at the same time must take other measures to prevent static and surge. Use anti-static bracelet, anti-static MATS, anti-static overalls, work shoes, gloves, anti-static container, are effective measures to prevent static and surge.



5、 Driving and cooling scheme

In the design of driving, by the current cannot exceed a maximum value specified products. Over voltage, over current pulses generated at the moment of the power switch or reverse voltage pulse may cause product damage and even death light. Therefore it is recommended that choose drive power selection of high stability. Because the heat this for product is concentrated, It should be the choice of high thermal conductivity thermal grease or conductive adhesive and Evenly coated on the light back. There can be no gap between substrate and radiator.



6、 Halogen

Halogen will damage the product, affecting device performance. Reference standards such as IEC, IPC and JPCA - ES, customers to use material, each kind of halogen content shall not be higher than 900 PPM, halogen sum shall not be higher than 1500 PPM.

Part No.: G7-XXXH0509-2314MX

- ✧ Halogen include: F, Cl, Br, I
- ✧ Common containing halogen material: white oil, pouring sealant, sealant, line insulation casing, etc.

7、 External force

Packaging adhesive products (including the white dam colloid) is fragile , when in use should pay attention to the following points:

- ✧ Do not use hard, sharp objects scratch, wipe the packaging adhesive part.
- ✧ Do not hand take products, avoid pollution package silica surface, and influence its optical properties.
- ✧ It should be noted that when using tweezers clip excessive pressure may damage , packaging silica gel , for example, damage, scratches, peeling, serious deformation and die lamp.
- ✧ Products dropped, the product may lead to deformation.

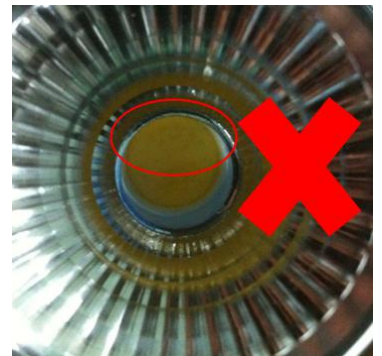
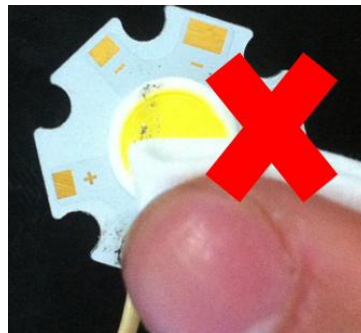

Part No.: G7-XXXH0509-2314MX

Model naming rules

G16-27 3 H 03 12-18 11 M A
X1 X2 X3 X4 X5 X6 X7 X8 X9 X10

- 一、X1: Substrate type
- 二、X2: Color temperature
- 三、X3: Tolerance range of Color tolerance or color temperature
- 四、X4: Ra
 - L : 70 +
 - H : 80 +
 - U : 90 +
 - X : 93 +
 - Y : 95 +
- 五、X5: The number of parallel
- 六、X6: The number of series
- 七、X7: }
八、X8: } X7 X8 X9 : Internal encoding
九、X9: }
- 十、X10: A:ANSI B:IEC C:Sunpu-6000K