

Supplier name:  
Ningbo Sunpu Led Co.,Ltd.,

Acknowledgment number:

## Product Acknowledgment

Customer Name:

Supply-side model:

Acknowledgment Effective Date:

Manufacturers		Client Confirm (Quality)		Client Confirm (R & D)	
Prepared		Qualified <input type="checkbox"/>		Qualified <input type="checkbox"/>	
		Unqualified <input type="checkbox"/>		Unqualified <input type="checkbox"/>	
Audit		Audit		Audit	
Approve		Approve		Approve	

( After both sides confirmed the Acknowledgment qualified,must be signed and sealed )

Supply-side Address: No 150.XinHui Road, Hi-Tech Park,Ningbo,china

Tel: 0574-87740939

## Fresh light COB

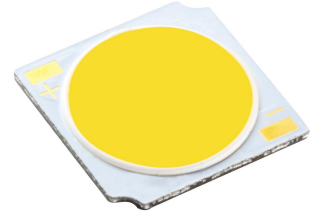

Fresh lighting is more real, more professional and more standardized.

1、The participants of standard formulation guarantee the professional quality of industry discourse power. Shengpu Optoelectronics actively participates in the formulation and improvement of domestic fresh light group standards. As a standard co-construction unit, it is deeply involved in key links such as core parameter setting and test method definition, so as to set up professional lighting benchmarks for the industry and ensure that product technology always stays at the forefront of standardization and frontier.

2、Reject the "red hat lamp", so that the light no longer deceives the eyes.

To tackle the prevalent "red hat lighting" issue in the market – where excessive red light is used to mask color variations and freshness issues in meat products – we remain committed to authentically showcasing the true nature of meat. Through precise spectral design and high color rendering control, we effectively prevent color distortion, ensuring consumers see ingredients as they truly are.

3、Precise spectrum design to enhance the visual trust of food ingredients.

Light path solutions are customized for fresh application scenarios such as vegetables and meat to achieve natural red color of meat and full but not distorted color of fruit.



## Part No.: G17-40-3-N-8-12-48-29-A5-H7

### Outline dimensions

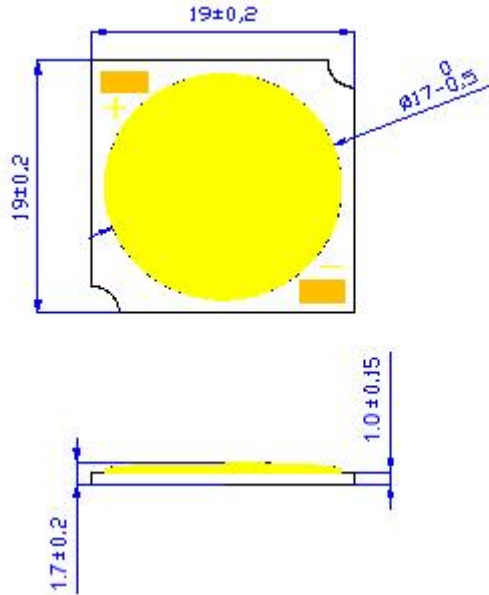

### Circuit structure

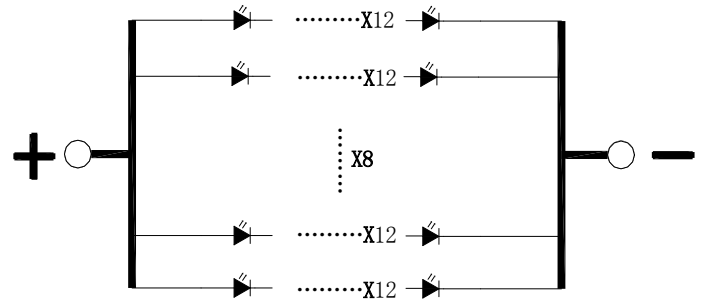

#### NOTES:

- ◇ All dimensions are millimeter.
- ◇ Tolerance is  $\pm 0.3\text{mm}$  unless otherwise noted.
- ◇ It is strongly recommended that the temperature of  $T_s$  (Welding plate) is not higher than  $90^\circ\text{C}$ .
- ◇ It is forbidden to store and use in the environment of sulfur and halogen elements.

### Limit parameter ( $T_a = 25^\circ\text{C}$ )

Parameter	Symbol	Test Condition	Value		Unit
			Min.	Max.	
DC Forward Current	$I_F$	----	----	1600	mA
Peak Pulse Current	$I_{\text{peak}}$	Duty=1/10 1kHz	----	2000	mA
Power Dissipation	$P_d$	----	----	61	W
LED Junction Temperature	$T_J$	----	----	125	$^\circ\text{C}$
Operating Temperature	$T_{\text{opr}}$	----	-40	+90	$^\circ\text{C}$
Storage Temperature	$T_{\text{str}}$	----	-40	+100	$^\circ\text{C}$
ESD Sensitivity	----	HBM	2000	----	V
Soldering Temperature	----	----	350 $^\circ\text{C}$ for 5 Seconds max		

**Part No.: G17-40-3-N-8-12-48-29-A5-H7**
**Photoelectric parameters (Ta = 25°C)**

Parameter	Symbol	Test Condition	Min	Typ	Max	Unit
Forward Voltage	$V_F$	IF =890mA	--	35	--	V
Luminous Flux	$\Phi_v$		3650	4050	--	lm
Color Temperature	CCT		3890	4050	4220	K
Color Rendering	$R_a$		90	--	--	
Thermal Resistance	$R_J$		--	0.8	--	°C/W

**Part No.: G17-40-3-N-8-12-48-29-A5-H7**

**Typical curves:**

Fig.1 Forward Current (mA) Vs Forward Voltage (V)

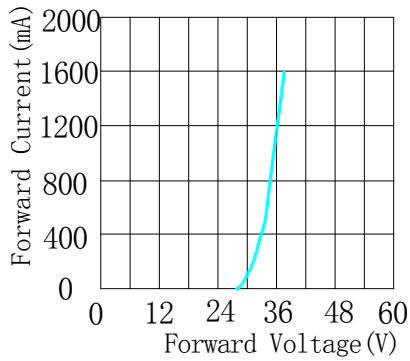

Fig.2 Relative Intensity Vs Forward Current (mA)

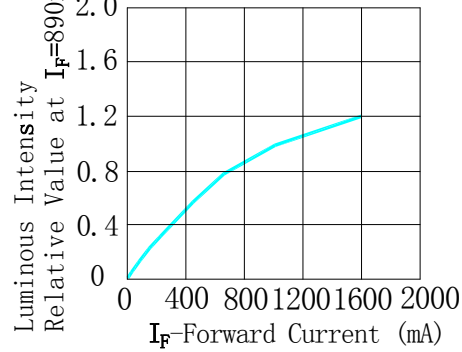

Fig.3 Forward Current Vs Temperature of Ts

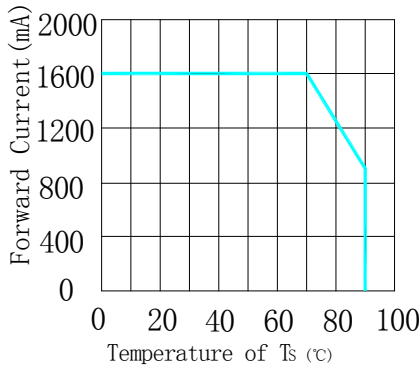
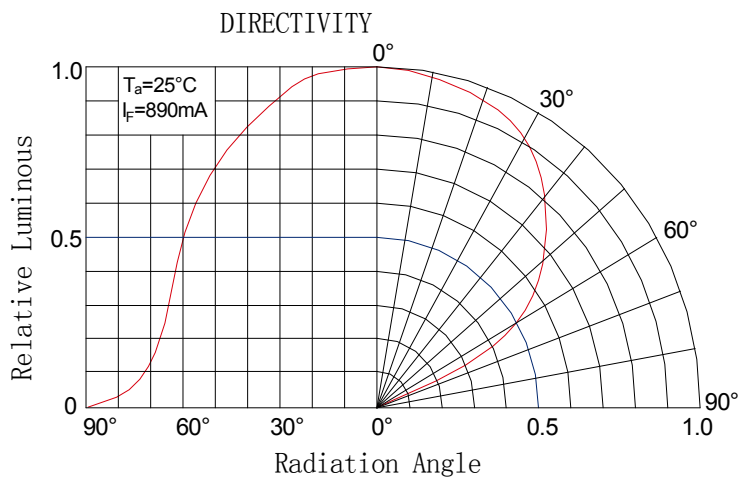
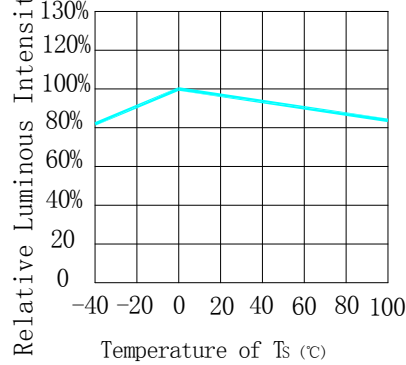
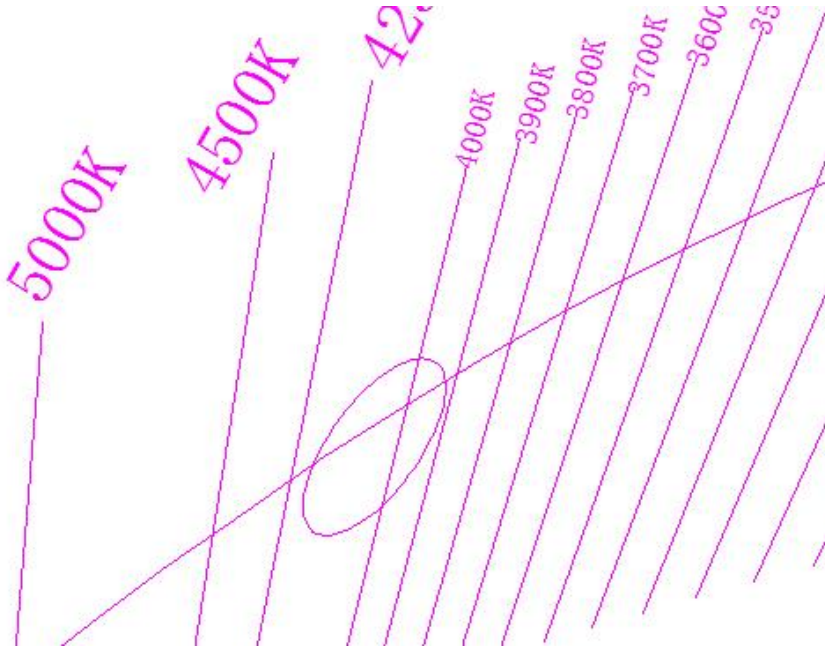

Fig.4 Relative Intensity Vs Temperature of Ts



## Part No.: G17-40-3-N-8-12-48-29-A5-H7

**Chromaticity Coordinates Ranks(I<sub>F</sub>=890mA Ta=25°C)**



Colour temperature	Center of Coordinates		Long axis	Minor axis	Gradient	Explain
	X	Y	a	b	θ	
4000K	0.3777	0.3731	0.00939	0.00402	53.72	SDCM 3-step MacAdam

**Notes:**

- ✧ Tolerance of measurements of the Forward Voltage is ±2%V
- ✧ Tolerance of measurements of the Luminous Flux is ±15%
- ✧ Tolerance of measurements of the Color Rendering R<sub>a</sub> is ±2
- ✧ Chromaticity Coordinates (x,y) is measured with an accuracy of ±0.01
- ✧ Ranking at T<sub>c</sub>=25°C

**Part No.: G17-40-3-N-8-12-48-29-A5-H7**

### Reliability Tests and Results

Test	Reference Standard	Test Conditions	Test Duration	Units Failed/Tested
High Temperature Storage	JEITA ED-4701 200 201	$T_A=100^{\circ}\text{C}$	1000hours	0/10
High Temperature Humidity Storage	JEITA ED-4701 100 103	$T_A=85^{\circ}\text{C}$ RH=85%	1000hours	0/10
Low Temperature Storage	JEITA ED-4701 200 202	$T_A=-40^{\circ}\text{C}$	1000hours	0/10
High Temperature Operating Life	JESD22-A108D	$TC=85^{\circ}\text{C}$ $I_F=890\text{mA}$	1000hours	0/10
Electrostatic Discharges	JEITA ED-4701 300 304	HBM 2KV 3K $\Omega$ 100Pf 3pulses negative		0/10
Temperature Cycle *1	Sunpu-opto	$-40^{\circ}\text{C}$ (30min) $\sim$ (90s) $\sim$ $110^{\circ}\text{C}$ (30min) $\sim$ (90s) $-40^{\circ}\text{C}$	300cycles	0/10

NOTES:

\* Measurements are performed after allowing the LEDs to return to room temperature

Failure Criteria

Items	Conditions	Failure Criteria
Forward Voltage (VF)	$I_F=890\text{mA}$	>Initial value x 1.1
Luminous Flux ( $\Phi_V$ )	$I_F=890\text{mA}$	<Initial value x 0.7

Part No.: G17-40-3-N-8-12-48-29-A5-H7

### Packaging

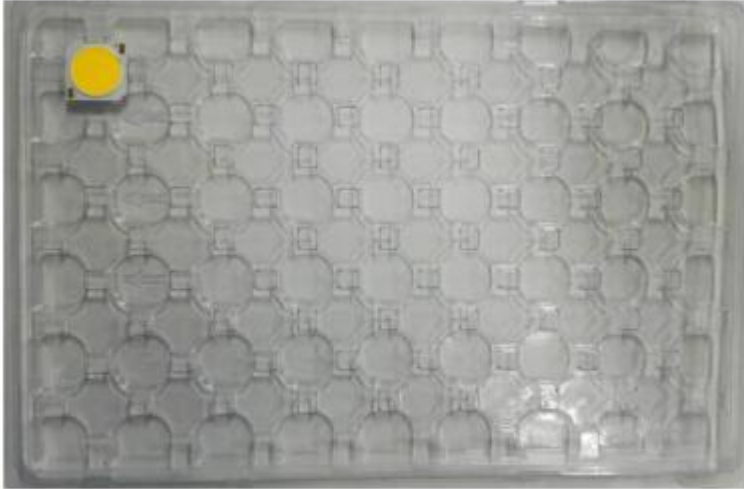

40 pcs/tray (5\*8=40pcs)

### Label instructions

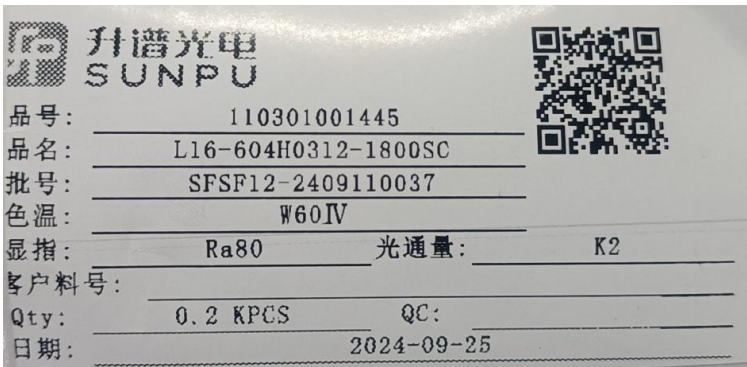

## Using and attention

### 1、 Soldering

COB light source device is a very fragile encapsulation device. Careless in the process of soldering operation will cause the damage of the products easily and even lead to death lamp. client should be cautious. In the process of soldering iron or other welding equipment to heat up, please don't use hand or other items to put any pressure on the surface of a product, please avoid iron touch within white rubber dam. because under the white dam it is likely to be the gold thread connection with substrate. If it is extruded by any external things, it is likely cause that connections between gold wire and substrate loose or fall off leading to product stroboscopic at work or death lamp. soldering temperature shall not be higher than 350 °C and the time shall not be more than 3 seconds and the number less than 2 times. When the soldering operation is completed , it is necessary that the product is cooled to room temperature, then washed again, and other operations.



### 2、 Cleaning

After soldering it is recommended that client should use alcohol to clean, The specific method is that Using tweezers clamping alcohol cotton ball in the source surface lightly wipe back and forth to clean,

**Part No.: G17-40-3-N-8-12-48-29-A5-H7**

Prohibit the forceps tip injury to the source surface .Before using other similar solvent cleaning, please make sure that to use the solvent will not damage the product packaging materials such as silica gel and phosphor etc.

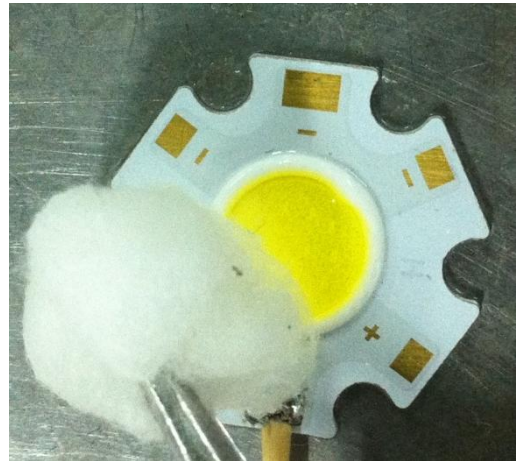
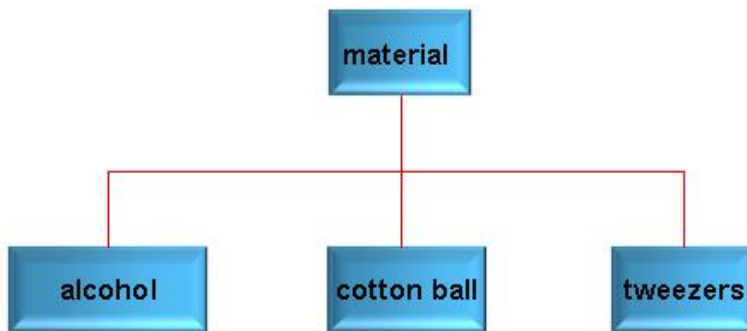

### 3、 Storage

This product use sealed moisture-proof anti-static bag packaging, storage method is as follows:

- ✧ Opened before, the product must be stored in room temperature and humidity environment is not higher than 70% RH.
- ✧ Once opened, the product can be stored in room temperature and humidity is not higher than 70% RH of the environment in a week, please use in the period of time.

If not timely installation after opening, Should be stored in dry cabinet temperature and humidity not higher than 10%RH .

### 4、 Static electricity

Static and surge can cause product characteristics change, such as forward voltage to reduce, if severe cases may even damage the product. So When in use effective anti-static measures must be taken. All

## Part No.: G17-40-3-N-8-12-48-29-A5-H7

related equipment and machines should be properly grounded, at the same time must take other measures to prevent static and surge. Use anti-static bracelet, anti-static MATS, anti-static overalls, work shoes, gloves, anti-static container, are effective measures to prevent static and surge.



### 5、 Driving and cooling scheme

In the design of driving, by the current cannot exceed a maximum value specified products. Over voltage, over current pulses generated at the moment of the power switch or reverse voltage pulse may cause product damage and even death light. Therefore it is recommended that choose drive power selection of high stability. Because the heat this for product is concentrated, It should be the choice of high thermal conductivity thermal grease or conductive adhesive and Evenly coated on the light back. There can be no gap between substrate and radiator.



### 6、 Halogen

Halogen will damage the product, affecting device performance. Reference standards such as IEC, IPC and JPCA - ES, customers to use material, each kind of halogen content shall not be higher than 900 PPM, halogen sum shall not be higher than 1500 PPM.

**Part No.: G17-40-3-N-8-12-48-29-A5-H7**

- ✧ Halogen include: F, Cl, Br, I
- ✧ Common containing halogen material: white oil, pouring sealant, sealant, line insulation casing, etc.

7、 External force

Packaging adhesive products (including the white dam colloid) is fragile , when in use should pay attention to the following points:

- ✧ Do not use hard, sharp objects scratch, wipe the packaging adhesive part.
- ✧ Do not hand take products, avoid pollution package silica surface, and influence its optical properties.
- ✧ It should be noted that when using tweezers clip excessive pressure may damage , packaging silica gel , for example, damage, scratches, peeling, serious deformation and die lamp.
- ✧ Products dropped, the product may lead to deformation.

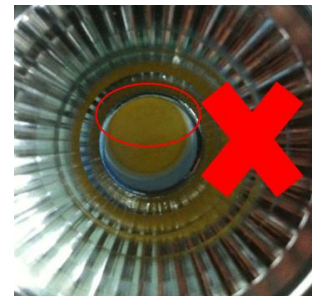

Part No.: G17-40-3-N-8-12-48-29-A5-H7

Model naming rules

<u>G16</u>	<u>27</u>	<u>3</u>	<u>H</u>	<u>01</u>	<u>12</u>	<u>06</u>	<u>04</u>	<u>M</u>	<u>A</u>
X1	X2	X3	X4	X5	X6	X7	X8	X9	X10

一、X1: Substrate type

二、X2: Color temperature

三、X3: Tolerance range of Color tolerance or color temperature

四、X4: Ra

L : 70 +

H : 80 +

N : 90 +

X : 93 +

Y : 95 +

五、X5: The number of parallel

六、X6: The number of series

七、X7:

八、X8:

九、X9:

十、X10:

X7 X8 X9 X10 : Internal encoding